

City of Milpitas

New Zoning Districts (Zoning Ordinance Update Phase I)

Public Hearing Draft | April 2024

Prepared for:



City of Milpitas
455 East Calaveras Boulevard
Milpitas, CA 95035

Prepared by:



Lisa Wise Consulting, Inc.
870 Market Street, Suite 977
San Francisco, CA 94102

This page intentionally left blank.

Table of Contents

Section 2: Definitions

XI-10-2.01 Purpose and Intent.....	1
XI-10-2.02 General Definitions.....	1
XI-10-2.03 Definitions.....	2

Section 3: Zoning Districts

XI-10-3.01 Districts	27
XI-10-3.02 Combining Regulations.....	28
XI-10-3.03 Zoning Map.....	28
XI-10-3.04 Letter Designation Includes All Aspects of the Zone	28
XI-10-3.05 Most Restrictive and Least Restrictive Zones	28
XI-10-3.06 Reference to General Provisions and Exceptions	28

Section 7: Industrial Zones and Standards

XI-10-7.01 Purpose and Intent.....	29
XI-10-7.02 Industrial Use Regulations	29
XI-10-7.03 Industrial Zone General Development Standards	33
XI-10-7.04 Industrial Zone Special Development and Performance Standards.....	35
XI-10-7.05 Special Design Standards for the BPRD Zone	36
XI-10-7.06 Conformance with Specific Plans	42

Section 9: Metro Area Zones and Standards

XI-10-9.01 Purpose and Intent.....	43
XI-10-9.02 Metro Area General Use Regulations	44
XI-10-9.03 Metro Area Special Use Regulations	49
XI-10-9.04 Metro Area General Development Standards.....	51
XI-10-9.05 Metro Area Special Development Standards	53
XI-10-9.06 Metro Area Special Design Standards	54

XI-10-9.07 Affordable Housing	60
XI-10-9.08 Exceptions to Standards.....	60

Section 53: Off-Street Parking Regulations

XI-10-53.01 Purpose and Intent	61
XI-10-53.03 Applicability	61
XI-10-53.05 Maintenance of Off-Street Parking	62
XI-10-53.07 Types of Parking Allowed	62
XI-10-53.09 Off-Street Parking Required by Land Use	63
XI-10-53.11 Shared Parking.....	69
XI-10-53.13 Design Standards	70
XI-10-53.15 Allowed Reductions to Required Parking for Lodging Uses.....	73

Section 54: General Provisions

XI-10-54.18 2023-2031 Housing Element Sites	76
---	----

Section 56: Nonconforming Buildings and Uses

XI-10-56.01 Purpose and Intent	77
XI-10-56.02 Repair, Maintenance and Improvements to Nonconforming Buildings and Structures	77
XI-10-56.03 Nonconforming Use of Buildings and Structures.....	78
XI-10-56.04 Nonconforming Use of Land.....	79
XI-10-56.05 Nonconforming Parcels.....	80

Section 2 Definitions*

* Prior ordinance history: Ords. 38, 38.19, 38.22, 38.39, 38.227, 38.339, 38.342, 38.355, 38.395, 38.485, 38.541, 38.551, 38.591, 38.603, 38.629, 38.646, 38.654, 38.667, 38.688, 38.694, 38.697, 38.702, 38.708, 38.710, 38.713, 38.754, 38.759, 38.760, 38.761, 38.763, 38.767, 38.770, 38.776 and 124.27.

XI-10-2.01 Purpose and Intent

The purpose of this chapter is to ensure precision in interpretation of this title. This section provides definitions of terms and phrases used in this Zoning Code that are technical or specialized, or that may not reflect common usage. If any of the definitions in this chapter conflict with definitions in other provisions of the Municipal Code, these definitions shall control for the purposes of this Zoning Code. If a word is not defined in this chapter, or other provisions of the Municipal Code, the most common dictionary definition is presumed to be correct.

(Ord. 38.780 (2) (part), 8/19/08)

XI-10-2.02 General Definitions

- A. The word "shall" is mandatory and not discretionary. The word "may" is permissive and discretionary.
- B. The word "should" indicates a guideline that must be followed in the absence of compelling considerations to the contrary.
- C. In the case of any difference of meaning or implication between the text of any provision and any caption or illustration, the text shall control.
- D. Unless the context clearly indicates to the contrary, words in the present and the future tense are interchangeable, and words in the singular and plural are interchangeable.
- E. Unless the context clearly indicates to the contrary, the following conjunctions shall be interpreted as follows:
 - 1. "And" indicates that all connected items or provisions shall apply;
 - 2. "Or" indicates the connected items or provisions apply singly; and
 - 3. "And/or" indicates the connected items or provisions may apply singly or in any combination; and
 - 4. "Either...or" indicates that the connected items or provisions shall apply singly but not in combination.
- F. The word "used" shall include arranged, designed, constructed, altered, converted, rented, leased, occupied, or intended to be utilized.
- G. The words "Planning Director" shall mean the Planning Director of the City or designee.
- H. The words "Planning Division" shall mean staff representing the City in implementing this chapter, the General Plan, and other regulations affecting land use.
- I. The words "City Engineer" shall mean the City Engineer of the City or designee.
- J. The words "Building Official" shall mean the Building Official of the City or designee charged with the administration and enforcement of the Building Code of the City of Milpitas.
- K. The words "City Manager" shall mean the City Manager of the City or designee.
- L. The words "Planning Commission" or "Commission" shall mean the City Planning Commission.

-
- M. The word "Council" shall mean the City Council, the governing body of the City.
- N. The word "City" shall mean the City of Milpitas.
- O. The word "County" shall mean the County of Santa Clara.
- P. The word "State" shall mean the State of California.
- Q. The words "Zoning Ordinance" or "this Chapter" or "Zoning Code" shall mean Title XI, Chapter 10 of the Municipal Code of the City.
- R. The words "General Plan" shall mean the General Plan of the City.
- S. The word "code" shall mean the municipal code of the City.
- T. Unless otherwise indicated, reference in this Chapter to whole numbers of sections includes all of the decimal-numbered paragraphs listed under such whole number section; i.e., a reference to Section 1.00 includes Subsections 1.01, 1.01-1 where the same are applicable.
- U. The word "lot" includes "plot".
- V. The word "building" includes "structure" except as specified.
- W. The words "Enforcement Officer" mean that person or persons specifically designated by the City Manager to enforce the provisions of this Chapter.
- X. The words "Zoning Administrator" shall mean the City Zoning Administrator.
- (Ord. No. 38.834 , § 4, 8/20/19; Ord. 38.780 (2) (part), 8/19/08)

XI-10-2.03 Definitions

A

"Abate" shall mean to repair, replace, remove, destroy or otherwise remedy the condition in violation of this Chapter.

"Accessory Building or Use" means a subordinate building or use, whose purpose is clearly incidental to that of the main building or the use of the land, and which shall not contain living or sleeping quarters or storage for commercial vehicles in excess of three-quarter ($\frac{3}{4}$) ton size. Accessory dwelling units, as defined in subsection XI-10-13.08 "Accessory Dwelling Units," are exempted from the prohibition against living and sleeping quarters. An accessory building shall be considered attached to the main building if:

1. It shares a common wall with the main building; or
2. It shares an integral roof structure having the same framing system and roof covering as the main building and is separated from the main structure by no more than ten (10) feet at any given point.

"Accessory Structure" means a structure subordinate to the principal use of a building on the same lot and serving a purpose customarily incidental to the use of the principal building. An accessory structure is that which an accessory building is not, by definition. Examples include, but are not limited to fences, trellises, covered patios, and porte cocheres.

"Active Use" means a use that attracts walk-in visitors and has a high degree of transparency from the street. Active uses include but are not limited to retail, restaurants, bars, markets, theaters, salons, yoga studios, art studios/galleries, banks, offices, and clinics. Active uses also include ground floor residential shared amenities, such as a lobby, gym, or conference room.

"Adjacent" means having a common border with, or being separated from such a common border by a right-of-way, alley or easement. Properties separated by a street, alley, intersection, or other public right-of-way (other

than an elevated interstate freeway), shall be considered abutting when their property lines would touch in any way if drawn to the center line of such street, alleyway, intersection, or other public right-of-way.

"Advanced Manufacturing" means the use of innovative technologies to create existing and new products or to improve products and processes. Advanced manufacturing focuses on the rapid transfer of science and technology into production activities and may incorporate high technology elements such as information, automation, computation, software, sensing, and networking. Advanced manufacturing may include storage space for raw materials and/or finished goods that actively supports the primary use.

"Airport" means any area of land or water designed, used, or intended to be used or set aside for the landing and taking off of aircraft. The term "Airport" includes all necessary taxi-ways, aircraft storage and tie-down area, hangars and other necessary buildings and open spaces.

"Alley" means any public thoroughfare which affords only a secondary means of access to abutting property.

"Alteration, Structural" means any change which would tend to prolong the life of the supporting members of a building or structure, such as bearing walls, columns, beams or girders.

"Amateur Radio Facility" means a wireless communication facility operated by an FCC licensed amateur radio operator within the Amateur Radio Service (USC Title 47, Part 97).

"Amateur Radio Operator" means a person holding written authorization to be the control operator of an Amateur Radio facility. This authorization may be in the form of a license or permit issued by the Federal Communications Commission or a foreign national or multi-national license or permit recognized by treaty as valid in the United States.

"Antenna" means any system of towers, poles, panels, rods, wires, drums, reflecting discs or similar devices used for the transmission or reception of electromagnetic waves. See also "Satellite dish or satellite antenna."

Apartment House. See "Dwelling, Multiple-Family."

Apartment, Efficiency. Efficiency apartment means a dwelling unit in a multi-family building consisting of not more than one (1) habitable room, together with kitchen or kitchenette and sanitary facilities.

~~"Assembly" means the provision of activities for assembled groups of participants at institutions or facilities including but not limited to private and nonprofit clubs; social or fraternal organizations; and churches, temples, synagogues and other places of worship. Assembly uses in the context of groups of people is distinct from and unrelated to the definition of the industrial use "Assembly from pre-processed materials."~~ "Assembly" see "Places of Assembly."

"Assembly from pre-processed materials" means assembling, packaging, or distributing from previously prepared materials, such as cloth, plastic, paper, leather, precious or semi-precious metals or stones, electric or electronic instruments and devices such as television, radios, and pharmaceutical products. Assembly in the context of industrial manufacturing is distinct from and unrelated to the definition of "Places of Assembly" involving groups of people.

"Auto" means any motor vehicle requiring a license pursuant to the California Vehicle Code.

~~"Automobile Service Station" means any premises used for supplying gasoline and oil at retail, direct to the customer, including minor accessories and services for automobiles, but not including automobile repairs.~~

"Auto Repair shop" means any shop, building, room, place or space wherein, for compensation, any automobile, other motor vehicle, or any parts thereof, are repaired, remodeled, overhauled, reconditioned, or painted.

"Automobile and Trailer Sales Area" means an open area, other than a street, used for the display, sale or rental of new or used automobiles or trailers, and where no repair work is done except minor incidental repair of automobiles or trailers to be displayed or sold on the premises.

"Automobile Wrecking" means the dismantling or wrecking of used motor vehicles or trailers, or the storage, sale or dumping of dismantled, partially dismantled, obsolete or wrecked vehicles or their parts.

B

"Bar or nightclub" means a commercial establishment serving alcoholic beverages for consumption on the premises where the service of food is only incidental to the consumption of such beverages. Dancing and live entertainment may also be conducted within the establishment.

"Basement" means a story, partly or wholly, underground. For purposes of height measurements, a basement shall be counted as a story where more than one-half (½) of its height is above the average level of the adjoining ground.

"Bay Window" means a window or set of windows jutting out from the wall of a building, rising from the ground and forming an alcove which may or may not add additional floor area or a sitting area within.

"Bedroom" means any room which meets the minimum requirements of both the Zoning Ordinance and the Building Code for a Habitable Room, which is constructed in such a manner that less than fifty (50) percent of one (1) wall is open to an adjacent room or hallway and which can be readily used for private sleeping purposes, shall be counted as a bedroom in order to determine parking or other requirements. For the purpose of calculating parking requirements, the following rooms which regularly make up a standard dwelling unit shall not be considered a "bedroom": one (1) kitchen, one (1) living room; one (1) family or recreation room; one (1) dining room; and the customary sanitary facilities. Planning staff shall determine whether or not a room qualifies as one of the above exceptions.

"Billiard Center" means a place for the public to view and participate in cuesports, such as, but not limited to, billiards, pocket billiards (e.g., pool), snooker, and the various forms of carom billiards.

"Billiards" means a "Recreation and Entertainment facility" for the public to view and participate in cue sports, such as but not limited to billiards, pocket billiards (e.g., pool), snooker, and the various forms of carom billiards.

"Block" means that property so designated on an official map of the City, or part of the City, or bounded by streets, or by a street or streets, and railroad right-of-way, canal right-of-way, or unsubdivided acreage.

"Boarding House" means an establishment where lodging is provided for compensation, generally for stays of more than 30 days, for up to 8 persons. Boarding houses typically have individual rooms for guests, shared bathroom facilities and a single common kitchen. Meals may be served for guests and included as part of the cost of lodging.

"Breezeway" means a covered passageway between buildings which does not exceed ten (10) feet in width and which has at least one side open, except for necessary supporting columns.

"Building" means a structure having a roof supported by columns or walls for the housing or enclosure of persons, animals, or chattels. Where a dwelling is separated by a division wall without openings, each portion of such dwelling shall be deemed a separate building.

Building, Height of. "Height of building" means the vertical distance measured from the adjoining curb grade to the highest point of the roof surface, if a flat roof; and to the mean height level between eaves and ridge for a gable, hip or gambrel roof; provided, however, that where buildings are set back from the street line, then the height may be measured from the average elevation of the finished grade along the front of the building.

Building, Main. "Main building" means a building in which is conducted the principal use of the lot on which it is situated. The main building shall contain all area within the interior faces of the building, including enclosed areas that are attached. In any "M" district any dwelling shall be deemed to be the main building on the lot on which the same is situated.

Building, Unit Group. "Unit group building" means two (2) or more buildings (other than dwellings) grouped upon a lot and held under single ownership such as universities, hospitals, institutions and industrial plants.

Business, Retail. "Retail business" means retail sale of any article, substance, or commodity for profit or livelihood conducted within a building, but not including the sale of lumber or other building materials or the sale of used or second-hand goods or materials of any kind.

"Business Support Services" means establishments primarily within structures that provide other businesses with ancillary services that further or facilitate the other businesses' primary activity. This term does not include activities or uses that are specifically listed as a conditionally permitted or prohibited use in the applicable zone. Examples of business support services include but are not limited to:

1. Business equipment repair services (except vehicle repair);
2. Commercial art and design (production);
3. Computer-related services (rental, repair);
4. Copying and quick-printing services;
5. Equipment rental businesses within structures;
6. Heavy equipment repair services where repair occurs ~~on the client site~~;
7. Janitorial services;
8. Mailbox rentals;
9. Mail advertising services (reproduction and shipping);
10. Other "heavy service" business services;
11. Outdoor advertising services;
12. Protective services (other than office related);
13. Rental, repairs and distribution of office or business equipment;
14. Window cleaning.

~~**Business, Wholesale.** "Wholesale business" means the wholesale handling of any article, substance or commodity for profit or livelihood, but not including the handling of lumber or other building material or the open storage or sale of material or commodity, and not including the processing or manufacture of any product or substance.~~

C

Camp, Trailer. "Trailer camp" means an area or tract of land used or designed to accommodate two (2) or more automobile or house trailers.

"Catering establishment" means an establishment in which the principal use is the preparation of food and meals on the premises, and where such food and meals are delivered to another location for serving and consumption.

"Candidate" means any person, party, referendum, initiative or other ballot measure.

"Cemetery" means land used or intended to be used for the burial of the dead and dedicated for cemetery purposes, including columbariums, crematories, mausoleums, and mortuaries when operated in conjunction with and within the boundary of such cemetery.

"Child Care Center" means any child care facility other than a family child care home, in which less than twenty-four (24) hour per day non-medical care and supervision are provided to children in a group setting. It

includes infant centers, preschools, and extended child day care facilities, but does not include after school programs.

"Class A Office Space" means a high quality, modern building with large floor plates and amenities that typically attracts rents in the top twenty-five percent (25%) bracket.

"College and University, Private" means a privately owned and operated college, community college, or university giving general academic instruction equivalent to the standards prescribed by the State Board of Education.

"Commercial Athletic Facility" means a building or site equipped for physical training or athletic type games and sports, such as but not limited to, health spas, tennis, gymnasiums, handball courts, racquetball courts; also including ancillary uses when incidental to the primary use, such as but not limited to, steam baths, weight training, aerobic classes, massage, saunas, and the retailing of athletic supplies to be used in the facility.

"Commercial Fueling Facility" means a fueling facility designed for commercial customers which dispenses gasoline, diesel, or similar vehicle fuels, and which is not open to the general public, has no cash sales and provides no personal services on-site, provided that said facility is located not closer than five hundred (500) feet from any residentially zoned district or any area designated on the General Plan as being "residential" or any mobile home park.

"Commercial Laboratory" means a facility for scientific research in technology-intensive fields. Examples include biotechnology, pharmaceuticals, genetics, plastics, polymers, films and fibers.

"Commissary" means a fixed-location kitchen where food is stored and prepared for off-site vending from mobile food vehicles. Commissaries serving mobile food vendors may include shared-use commercial kitchens, private commercial kitchens, restaurant kitchens, and kitchens associated with civic and community organizations such as churches or social clubs; but do not include catering service establishments.#

"Community Garden " means an area where neighbors and residents have the opportunity to contribute to and manage the cultivation of plants, herbs, vegetables, and fruits, generally on property under public or non-profit ownership. May consist of individually tended plots on a shared parcel or many be communal on a single plot.

"Condominium" means an estate in real property consisting of an undivided interest in common in a portion of a parcel of real property together with a separate interest in space in a residential, industrial, or commercial building on such real property, such as an apartment, office, or store. A condominium may include in addition a separate interest in other portions of such real property. Such estate may, with respect to the duration of its enjoyment, be either of the following:

1. An estate of inheritance or perpetual estate.
2. An estate of life.
3. An estate for years, such as leasehold or sub-leasehold.

"Condominium Conversion" means a change in the type of ownership of a parcel or parcels of land, together with the existing attached structures, to that defined for a condominium project or a community apartment project regardless of the present or prior use of such land and structures and whether substantial improvements have been made or are to be made to such structures.

"Conference Center" means a facility used for holding conventions, seminars, workshops or similar activities, including dining facilities and lounges for use by participants, as well as compatible accessory facilities such as offices and business centers.

"Continuing Violation" means a violation, infringement or breach of a provision of this chapter that is uninterrupted and lasts for a continuous period in excess of 24 hours.

"Contractor's Shop" means an establishment for specialized business activities related to building construction. This classification includes establishments for trades such as painting, carpentry, plumbing, glassworking, heating, air-conditioning, roofing, landscaping, cabinetmaking, and sign-making.

"Convenience Store" means a retail establishment selling food, beverages, and small convenience items such as personal hygiene products, cigarettes, magazines, etc. Food and beverage products sold primarily consist of packaged and canned goods, prepared foods and hot drinks for immediate consumption, fountain sodas, etc., with less than 10 percent of net retail floor area allocated for the sale of fresh fruits, fresh vegetables, fresh meat and dairy products, and other similar perishable items. Convenience stores are smaller in floor area than supermarkets/grocery stores (typically 4,000 square feet or less) and have long or late hours of operation (open before 7:00 am or after 10:00 pm).

"Court Dwellings" means a residential development in which there are several freestanding single-family or two-family dwellings with separate walls clustered on a single lot. Units are typically arranged to face around a common open space or drive aisle. If subdivided, a maintenance agreement or homeowners association may govern common areas like driveways or open space.

"Court" means an open unoccupied space, other than a yard, on the same lot with a building or buildings, and bounded on two (2) or more sides by a building, or buildings, including the open space in a dwelling group providing access to the units thereof.

"Court Apartment" means one (1), two (2) or three (3) multiple dwellings arranged around two (2) or three (3) sides of a court which opens onto a street, or a place approved by the Commission.

"Curb Grade" means the elevation of the established curb in front of the building measured at the center of such front. Where no curb grade has been established, the City Engineer shall establish such curb grade or its equivalent for the purpose of this Chapter.

"Custom and Artisan Manufacturing" means an establishment primarily engaged in on-site production of goods by hand manufacturing or artistic endeavor, which involves only the use of hand tools or small mechanical equipment and the incidental direct sale to consumers of only those goods produced on site. Typical uses include metalworking, pottery and ceramic studios, film processing, photo finishing, printmaking, lithography, glass furnace, or woodworking.

D

"Data Center" means a facility for the storage of computer systems and associated components.

"District" means a portion of the City within which certain uses of land and buildings are permitted or prohibited and within which certain yards and other open spaces are required and certain height limits are established for buildings, all as set forth and specified in this Chapter.

"Drive Through Uses" means any component or part of a building or structure which attracts or invites persons in motor vehicles to drive their vehicles upon the premises, and which is used to conduct business or used for the purpose of selling merchandise from the inside of said building to the occupants of motor vehicles.

"Dry-Cleaning Plant" means an establishment providing onsite, high-volume laundry and garment cleaning services, typically with the use of volatile solvents, including dry cleaning and garment pressing, diaper services, commercial laundries, and linen supply services. These facilities may include incidental onsite customer pick-up services.

"Dwelling" means a building or portion thereof designed exclusively for residential occupancy, including single-family, two-family and multiple-family dwellings, but not including hotels.

Dwelling, Group. "Group dwelling" means one (1) or more dwellings, other than a tourist court, arranged around two (2) or three (3) sides of a court, which opens onto a street, or a place approved by the commission, including single-family, two-family or multiple-family dwellings and court apartments. Group dwelling include homeless shelters and transitional housing.

Dwelling, Multiple-Family. "Multiple-family dwelling" means a building or portion thereof, designed for occupancy by three (3) or more families living independently of each other.

Dwelling, Single-Family. "Single-family dwelling" means a detached building designed exclusively for occupancy by one (1) family for living purposes and having only one (1) kitchen.

Dwelling, Two-Family. "Two-family dwelling" means a building designed exclusively for occupancy by two (2) families living independently of each other.

"Dwelling Unit" means a habitable room or group of habitable rooms (e.g., living room, bedroom, den, library, recreation, studio, etc.) designed for occupancy by one (1) or more persons living as a family or single household unit with common interior access to all living, kitchen and bathroom areas. No dwelling unit may have more than one (1) kitchen.

E

"EcoPass" means a program offered by the Valley Transportation Agency (VTA) in which employers or property owners purchase annual EcoPass stickers that allow their employees, tenants or residents to ride all VTA bus and light rail vehicles at no cost. ~~"Educational Institution" means a college or university giving general academic instruction equivalent to the standards prescribed by the State Board of Education.~~

"Electronic Smoking Device" means an electronic and/or battery-operated device, the use of which may resemble smoking that can be used to deliver an inhaled dose of nicotine or other substances. "Electronic Smoking Device" includes any such device, whether manufactured, distributed, marketed, or sold as an electronic cigarette, an electronic cigar, an electronic cigarillo, an electronic pipe, an electronic hookah, vaporizer or any other product name or descriptor.

"Elevation" means:

1. A scale drawing of the front, rear or side of a building or structure; or
2. A vertical distance above or below a fixed reference level.

Emergency Cache, Community. "Community emergency cache" means a collection of disaster response supplies approved by the City's Office of Emergency Services that would benefit the surrounding community.

"Emergency Shelter" means housing with minimal supportive services for homeless persons that is limited to occupancy of six months or less by a homeless person. No individual or household may be denied emergency shelter because of an inability to pay as set forth in the California Health and Safety Code Section 50801(e), as may be amended.

"Erosion" means the wear and removal of the material in the earth's crust from one site and the deposition at another.

"Extended Stay Hotel" means a commercial establishment providing lodging for a fee for guests, generally marketed to long-term visitors on a temporary basis, which contain furnishings and facilities for sleeping, bathing, food preparation and cooking, Kitchen facilities within individual units may include, but are not limited to, counters, refrigerators, stoves, and ovens.

F

"Family" means an individual, or two (2) or more persons related by blood or marriage or legal adoption or joined through a judicial or administrative order of placement or guardianship, or unrelated persons who function together as a single household unit.

"Family Child Care Homes" means a home in which care, protection, and supervision of fourteen (14) or fewer children is regularly provided, in the caregiver's own home, for periods of less than twenty-four (24) hours per day, while the parents or guardians are away. Such homes are licensed by the State of California and include the following:

1. **"Large family child care home"** means a home in which family child care is provided to nine (9) to fourteen (14) children, including children under the age of ten (10) who reside at the home.
2. **"Small family child care home"** means a home in which family day care is provided to eight (8) or fewer children, including children under the age of ten (10) who reside at the home.

"Farmers' Market" means an event offering for sale produce, food items, and related goods and merchandise by certified growers authorized to sell, directly to consumers, products that are produced on land the producer controls or taken in consignment from other producers. Excludes flea markets.

"Floor Area Ratio (FAR)" is defined for nonresidential Zoning Districts as the maximum permitted ratio of gross floor area to site area and is calculated as follows:

$$\text{FAR} = \frac{\text{Total of Gross Floor Area for All Structures on Site}}{\text{Site Area}}$$

"Frontage" means all the property fronting on one side of a street between intersecting or intercepting streets, or between a street and a right-of-way, waterway, end of dead-end street, or city boundary, measured along the street line. An intercepting street shall determine only the boundary of the frontage on the side of the street which it intercepts.

G

Garage, Private. "Private garage" means a detached accessory building or portion of a main building for the parking or temporary storage of automobiles of the occupants of the premises.

Garage, Public. "Public garage" means a building, other than a private garage, used for the care, repair, or equipment of automobiles, or where such vehicles are parked or stored for remuneration, hire or sale.

Game Machine, Mechanical or Electronic. "Mechanical or electronic game machine" means any machine, apparatus, contrivance, appliance, or device which may be operated or played upon the placing or depositing therein of any coin, check, slug, ball, token, or any other article or device, or by paying therefore either in advance or after use, involving in its use either skill or chance, including, but not limited to tape machine, card machine, pinball machine, bowling game machine, shuffleboard machine, marble game machine, horse racing machine, basketball game machine, baseball game machine, football game machine, electronic video game or any other similar machine or device, exclusive of food, beverage and tobacco vending machine.

Grade, Finished. "Finished grade" means the final elevation of the ground surface after development, as shown on a precise Grading Plan.

"Grocery Store" means any premises wherein any of the following are exposed, offered for sale, or sold by retail: fresh fruits; fresh vegetables; bakery; meat; poultry, or fish products; frozen foods; and processed and pre-packaged food.

"Grocery Store, Small" means any premises less than 15,000 gross square feet in area wherein any of the following are exposed, offered for sale, or sold by retail: fresh fruits; fresh vegetables; bakery; meat; poultry, or fish products; frozen foods; and processed and pre-packaged food.

"Gross Acreage" means the total area within the boundaries of a legal lot or parcel, including any area proposed to be dedicated or reserved for public right-of-way. Adjacent lands already dedicated for public right-of-way, including public roadways, easements or other areas, shall not be included as part of the gross acreage.

"Gross Floor Area" means the total of all floors measured from the interior faces of the building, but not including areas for parking, basements, shaft enclosures, or unroofed inner courts unless any outdoor areas are used for retail purposes.

"Group Living Accommodations" means a building or portion of a building designed for or accommodating a residential use by persons not living together as a household. This use includes dormitories, convents and monasteries, and other types of organizational housing. This use does not include residential care facilities, nursing homes, hotels, single room occupancy residences, or boarding houses. Group living accommodations typically provide shared living quarters without separate kitchen or bathroom facilities for each room or unit.

"Guest House Accessory Building" means a one accessory structure, used for the accommodation of guests. Said guest house shall not contain any kitchen or cooking facilities but may contain one (1) bedroom, one (1) living area and one (1) bathroom, and shall be limited in floor area to a maximum of twenty (20%) percent of the total floor area of the main residence.

H

"Habitable Space" means a room designed for living, sleeping, eating or food preparation, including but not limited to a den, study, library, home office, sewing room or recreational room and excluding such areas as garages.

"Hazardous Material" means a material identified as hazardous by California Health and Safety Code Section 25502(n).

"Head/Smoke/Tobacco Shop" means a retail establishment primarily engaged in the selling of smoking and tobacco products and accessories, and other products, devices and components reasonably assumed to be used for smoking and/or the inhalation or ingestion of any substances. Tobacco products may include but are not limited to cigarettes, cigars, loose leaf tobacco, tobacco pipes, Electronic Smoking Devices and accessories, vaporizers and accessories and any other product, device or component used in the inhalation of tobacco, nicotine or other substance. For the purposes of this definition only, "primarily engaged" means when thirty percent (30%) or more of products sold at the retail establishment are smoking and tobacco products and accessories, and other products, devices and components reasonably assumed to be used for smoking and/or the inhalation or ingestion of any substance.

"Home Occupation" means a business enterprise conducted within a dwelling by the residents of the dwelling and which is incidental and secondary to the use the dwelling for residential purposes.

"Hospital" means an institution that maintains and operates facilities for primarily inpatient medical care, including x-ray, laboratory and surgical, for the diagnosis, care and treatment of human illness, injury and disease (physical or mental).

"Hotel" means a commercial establishment providing lodging accommodations for a fee for transient guests, generally for stays of 30 days or less, with access to rooms or units primarily from interior lobbies, courts or halls. A hotel may include limited facilities for storage and preparation of food and beverages within individual rooms, such as coffee makers, mini refrigerators and microwave ovens.

I

"Individual Violation" means a noncontinuous condition or occurrence in violation, infringement or breach of a provision of this chapter that does not exceed twenty-four (24) hours in duration. An Individual Violation may be recurrent. Examples of "Individual Violations" for the purposes of this Chapter include, but are not limited to, the illegal outdoor storage of materials, entertainment events, or outdoor seating in violation of a use permit.

"Instruction, group and private" means the provision of instructional services, including but not limited to photography, fine arts, crafts, dance or music studios, driving schools, diet centers, yoga, martial arts studios, after school programs or similar uses. This definition does not include instruction received through trade or vocational schools nor a post-secondary school or child care centers. Private instruction includes fewer than six (6) students or clients at any one time and group instruction includes six (6) or more students or clients at any one time.

"Intensity" means the degree to which land is used, measured by a combination of the type of land used and the amount of land or floor area devoted to that use.

"Intensification of Use" means to alter the character of a use to the extent that the use generates new or different impacts on the health, safety, or welfare of the surrounding neighborhood, including but not limited to the level or amount of traffic, noise, light, smoke, odor, vibration, outdoor storage, or other similar conditions associated with the use.

J

"Junk Yard" means the use of more than one hundred (100) square feet of the area of any lot for the storage of junk, including scrap materials and metals, or wrecked vehicles and machinery, whether or not sale of such junk is made or proposed.

K

"Kennel" means any lot or premises on which four (4) or more dogs, more than four (4) months of age, are kept.

"Kitchen (for residential uses)" means a residential kitchen shall be enclosed and interior to the dwelling unit utilized for the preparation of food and include two (2) or more of each of the following:

1. A sink (typically larger than 14" × 17");
2. A full size refrigerator (typically larger than 24" × 64");
3. A 220-V electrical service outlet (typically used for major cooking appliances such as a stove, oven or cooking range).

L

"Laundromat" means a primarily self-service facility where customers wash and dry clothing and other textiles in on-site machines, and where ancillary full-service laundry services may also be offered.

"Live-Work Unit" means a dwelling unit with a separate living space attached to a work space within the same unit. The work space and the living space must be occupied by the same tenant. Live-work uses allow one non-residential employee, more customers, and a broader range of uses than permitted in Home Occupations. See XI-10-13.12 within Special Uses for Live-Work Unit purpose, intent, and regulations.

Uses permitted or conditionally permitted within the underlining zoning district apply unless otherwise prohibited in Section 10-13.12(E). Additional uses covered by this designation include, but are not limited to:

- Art and craft work;
- Offices, Business and Professional;
- Artists and artisans;
- Fashion.

"Loading Area" means an open area, other than a street or alley, used for the loading or unloading of vehicles.

"Loading Space" means an off-street space or berth on the same lot with a building, or contiguous to a group of buildings, for the temporary parking of a commercial vehicle while loading and unloading merchandise or materials, and which abuts upon a street or other appropriate means of access.

"Lot" means land occupied or to be occupied by a building, or unit group of buildings, and accessory buildings, together with such yards and lot area as are required by this Chapter and having its principal frontage upon a street or a place approved by the Commission.

1. **"Corner lot"** means a lot, or portion thereof, not greater than seventy-five (75) feet in width and situated at the intersection of two (2) or more streets.

-
2. **"Flag lot"** means a lot having access or an easement to a public or private street by a narrow, private right-of-way.
 3. **"Interior lot"** means a lot other than a corner lot.
 4. **"Key lot"** means a lot with a side line that abuts the rear line of any one (1) or more adjoining lots.
 5. **"Reversed corner lot"** means a corner lot the street line of which is substantially a continuation of the front line of the lot to its rear.
 6. **"Through lot"** means a lot having frontage on two (2) paralleled or approximately paralleled streets.

"Lot Dimensions."

1. **"Lot Area"** means the total horizontal area within the lot lines of a lot.
2. **"Lot Depth"** means the horizontal distance between the front and rear lot lines, measured along the median between the two (2) side lot lines.
3. **"Lot Lines"** means the lines bounding a lot as defined herein.
 - a. In the case of an irregular shaped lot or a lot with more than four (4) sides where there is question as to which are the front, side, and rear property lines in order to determine setbacks and required yards, there shall be at a minimum of one (1) front property line and one (1) rear property line. The rear property line shall be the lot line directly parallel to the front property line and of a width of at least thirty (30) feet in length. If no such lot line exists, the Director of Planning shall make the final determination as to the rear property line of such lot.
4. **"Lot Width"** means the horizontal distance between the side lot lines, measured at right angles to the lot depth at a point midway between the front and rear lot lines.

M

"Manufacture/Manufacturing" means the preparation, making, treatment, or processing of articles as merchandise.

"Massage Establishment" means any establishment having a fixed place of business where any person, firm, association, partnership, corporation or other entity engages in, conducts, or carries on, or permits to be engaged in, conducted or carried on, any massage for compensation. For the purpose of this Chapter, the term "massage establishment" shall also include, but not be limited to, any business providing off-premises massage services.

"Massage Establishment, Accessory" means an establishment that provides massage which is incidental to the primary business, where the owner of the primary business is responsible for the massage services and conduct of the massage technician(s) employed at the location.

"Medical and Dental Offices" means a building or place where (a) member(s) of the medical profession, dentists, chiropractors, osteopaths, acupuncturists, and physicians or occupational therapists provide diagnosis and treatment to the general public without overnight accommodation and shall include such uses as reception areas, offices, consultation rooms, pharmacy and x-ray providing that all such uses have access only from the interior of the building or structure.

"Medical and Dental Clinics" means the same as Medical and Dental Offices, except they also include minor operating rooms and out-patient surgery with no overnight stay.

"Medical Support Laboratory" means a facility for scientific laboratory analysis of medical resources. The analysis is generally performed for an outside customer, to support the work of that customer.

"Micromobility Device" means a small, lightweight vehicle operating at a speed typically below 15 miles per hour and driven by the individual user, such as bicycles, e-bikes, and electric scooters.

"Mixed Use Development" means a development that consists of vertical or horizontal combination of residential and commercial uses within a single building or site.

"Mobile Fueling" means a commercial service that offers on-demand fueling of motor vehicles at a specified location instead of at a service station. Mobile fueling may be provided to individual customers via the use of a mobile app, with fuel delivered to a home, office, or other location requested by the customer. Mobile fueling may also be provided for operators of fleet vehicles at a fixed, semi-permanent or permanent location.

"Mobile Home" means a transportable structure designed to be used as a dwelling unit when connected to required utilities.

"Mobile Home Accessory Building or Structure" means any awning, portable, demountable or permanent cabana, ramada, storage cabinet, carport, fence, windbreak or porch established for the use of the occupant of the mobile home.

"Mobile Home Lot" means a portion of mobile home park designated or used for the occupancy of one mobile home.

"Mobile Home Park" means any areas or tract of land where mobile home lots are rented or leased or held out for rent or lease to accommodate mobile homes used for human habitation.

"Mobile Home Stand" means the area on which the mobile home is placed when it is stationed on the lot, including the land lying under the mobile home.

"Mobile Recycling Unit" means an automobile, truck, trailer or van, licensed by the Department of Motor Vehicles or bins, boxes or containers transported by a truck, van or trailer, and used for the collection of recyclable materials.

"Motel" means a building or group of attached or detached buildings providing lodging accommodations for a fee for transient guests, generally for stays of 30 days or less, with access to each room or unit through an exterior door. Motels are distinguished from hotels primarily in that the former provide direct independent access to, and adjoining parking for, guest rooms and do not provide 24-hour guest services.

N

"Natural Land Slope" means the average slope of the lot in percent, determined by observation on simple slopes, or more precisely by the formula:

$$S = 100 \frac{I}{L A}$$

Where:

I is the contour interval in feet;

L is the combined length of the contour lines in scale feet; and

A is the net area of the lot in square feet.

"Nonconforming Building" means a building or structure or portion thereof lawfully existing at the time this Chapter became effective, which was designed, erected or structurally altered, for a use that does not conform to the use regulations of the district in which it is located. A nonconforming building shall also mean any building or structure built in compliance with all city land use and zoning laws in existence at the time and which does not comply with current development standards, including but not limited to height, setbacks, floor area ratio, maximum lot coverage, maximum size of residence, front yard paving and impervious surface coverage.

"Nonconforming Use" means a use which lawfully occupied a building or land at the time this Chapter became effective and which does not conform to the use regulations of the district in which it is located.

O

"Occupation" means a principal business, profession or vocation in which one is regularly and habitually engaged for the purpose of compensation for a livelihood.

"Offices, Business and Professional" means offices of firms or organizations providing professional, management, or administrative services, including but not limited to:

~~Accounting;~~

~~Architectural;~~

~~Business~~ accounting, architectural, business and management consulting;

~~Computer, computer~~ and technology;

~~Engineering; Insurance;~~

~~Insurance;~~

~~Interior, engineering, insurance, interior~~ design;

~~Graphic, graphic~~ design;

~~Real, real~~ estate;

~~Title, title~~ companies;

~~Legal, and legal~~ services

. This classification ~~does~~ includes co-working spaces designed to accommodate different organizations that provide such services. Does not include medical and dental offices, ~~which have a separate definition.~~ or financial institutions such as retail and commercial banks.

"Open-Air Business" means drive-in business where persons are served in automobiles.

"Outdoor Music" means live music, both acoustic and amplified, including live individual musicians, bands, and disc jockeys (DJs), but not including karaoke, that takes place on a patio or other outdoor space. Outdoor music as defined and regulated in this Chapter shall also include recorded background music played outdoors at a public establishment such as a restaurant, bar, retail store, or other business.

"Owner/Occupant" means any person owning property, as shown on the last equalized assessment roll for City taxes, or the lessee tenant, or other person having control or possession of the property.

P

"Parcel" shall mean a legal lot of record.

"Parcel Hub" means a "last mile" warehouse or similar establishment for the processing and/or redistribution of parcels or products to end-user customers. A Parcel hub's primary function is moving a shipment from one mode of transport to vehicles with rated capacities less than 10,000 pounds, for delivery directly to consumers or end-users primarily within a ten-mile radius.

Parking Area, Private. "Private parking area" means an open area, other than a street or alley, used for the parking of the automobiles of occupants of a building.

Parking Area, Public. "Public parking area" means an open area, other than a private parking area, street or alley, used for the parking of automobiles and available for public or quasi-public use.

Parking Space, Automobile. "Automobile parking space" means a space within a building or a private or public parking area for the parking of one (1) automobile.

"Parking Structure" means a structure or portion thereof composed of one or more levels or floors used exclusively for the parking or storage of motor vehicles. A parking structure may be totally below grade (as in an

underground parking garage) or either partially or totally above grade with those levels being either open or enclosed.

"Patio Cover" means a one-story structure, not exceeding twelve (12) feet in height and open on one (1) or more sides (provided, however, that the open sides may be closed with insect or plastic screening that is permeable material and not in any manner that would obstruct the free passage of light or air) used for recreational, outdoor living purposes only and not as carports, storage rooms or habitable rooms.

"Person" means a natural person, his heirs, executors, administrators, or assigns, and also includes a firm, partnership or corporation, its or their successors or assigns, or the agent of any of the aforesaid.

"Personal Services" means a commercial establishment which provides services of a personal or aesthetic nature directly to consumers, including but not limited to:

1. Beauty salons and barber shops;
2. Nail salons;
3. Tanning salons;
4. Hair removal salons;
5. Tattoo studios;
6. Body piercing studios.

"Place" means an open, unoccupied space, other than a street or alley, permanently reserved as the principal means of access to abutting property.

"Places of Assembly." See **"Assembly"** **"Places of Assembly" means an institution or facility that offers or hosts activities for assembled groups of participants, including but not limited to private and nonprofit clubs; social or fraternal organizations; and churches, temples, synagogues, and other places of worship. This use is distinct from and unrelated to the industrial use "Assembly from pre-processed materials."**

"Private Recreational Areas" means any usable open space or recreational facility available for use by all of the site's residents.

"Property" means all real property and fixtures, including, but not limited to, parking lots, sidewalks, gutters, driveways, walkways and any building and structure located on such property.

"Public Right-of-Way" as defined in Section V-500-1.13 of the Milpitas Municipal Code, shall mean the full width of the right-of-way of any street or bicycle pathway, as defined in the California Vehicle Code used by the general public, whether or not such street or path has been accepted as and declared to be part of the City system of streets and paths, including streets forming a part of the State Highway System. "Public right-of-way" also includes easements where the City is the grantee of the easement and property owned by the City of Milpitas or the Milpitas Redevelopment Agency and any public park, trail, or right-of-way within the City of Milpitas.

"Public Safety Use" means facilities for public safety or emergency services, including police and fire protection.

"Public Service Use" means facilities owned and operated by governmental agencies that provide services to the general public, including but not limited to federal, state and municipal administration buildings, courthouses, and post offices.

"Public Use" means a use intended to serve the whole city and/or region and operated by a public institution or entity. Such uses have the purpose primarily of serving the general public and include public schools, recreational facilities, government housing, government clinics, and the like.

"Public Utilities" means facilities for the production, storage, treatment, transmission and/or distribution of electricity, natural gas, water, wastewater, and telecommunications and other similar essential services. Also includes service facilities, electric transmission and distribution substations and public utility service centers.

Q

"Quasi-Public Use" means a use intended to serve the whole city and/or region and are operated by a private, nonprofit, educational, religious, recreational, or charitable, and having the purpose primarily of serving the general public. Such uses include religious facilities, private schools, community theaters, community and club organizations, private hospitals, places of assembly and the like.

F

R

"Recreation or Entertainment Facility" means a commercial establishment (indoors or outdoors) where patrons can actively participate in entertainment or recreation activities either independently or in conjunction with other uses.

"Recyclable Material" means reusable material including but not limited to metals, glass, plastic and paper, which are intended for reuse, remanufacture, or reconstitution for the purpose of using the altered form. Recyclable material does not include refuse or hazardous materials. Recyclable material may include used motor oil collected and transported in accordance with the California Health and Safety Code.

"Recyclable Processing Facility" means a building or space used for the collection and processing of recyclable materials. Processing means the preparation of material for shipment by such means as baling, briquetting, compacting, flattening, grinding, crushing, sorting, shredding, cleaning and remanufacturing.

"Repair and Cleaning, Small Items" means a commercial establishment that performs cleaning, repair, and alteration of small consumer and household items, such as laundromats (self-service laundries), dry cleaning pick-up stores (where cleaning is done off-site), tailors, shoe repair shops, jewelry and watch repair shops, and locksmiths. Excludes dry-cleaning plants, business equipment and computer repair, heavy equipment and machinery repair, repair and servicing of large and bulky household items such as appliances and furniture, or vehicle repair.

"Research and Development (R and D) Uses" means ~~one industrial or more buildings which feature a combination of offices, manufacturing, assembly, warehousing, distribution, laboratories~~ scientific research for the design, development, engineering and testing of high technology, clean rooms, technology, industrial, or scientific products. Research and ancillary development uses such may include limited manufacturing as cafeterias necessary for the production of prototypes, but exclude the full-scale manufacturing of final products. Research and employee fitness development uses may also include storage space for raw materials and/or finished goods that actively supports the primary use.

"Residential Care Facility" means a facility licensed by the State of California to provide living accommodations, 24-hour care for persons requiring personal services, supervision, protection, or assistance for sustaining the activities of daily living for more than six individuals. Living accommodations are group homes or shared living quarters with or without separate kitchen or bathroom facilities, for each room or unit. This classification includes facilities that are operated for profit as well as those operated by public or not-for-profit institutions.

"Restaurant" means an establishment in which the principal use is the preparation and sale of food and non-alcoholic beverages. If approved, the service of alcoholic beverages is incidental to the principal use.

1. **"Drive-in"** means a restaurant that delivers prepared food and/or beverages to customers in motor vehicles, regardless of whether or not it also serves prepared food and/or beverages to customers who are not in motor vehicles, for consumption either on or off the premises.
2. **"Drive-thru"** means a restaurant which includes one (1) or more drive-through lanes for the ordering and receipt of foods and/or beverages by patrons remaining in their vehicles.

-
3. **"Fast-food"** means a restaurant that offers quick food service, which is accomplished through a limited menu of items already prepared and held for service, or prepared. Orders are generally not taken at the customer's table, and food is generally served for consumption either on or off the premises. For the purposes of parking requirements, the ordering or take-out area is defined as the counter and the area between the counter and the main entry to the establishment.
 4. **"Take-out"** means a restaurant where foods and/or beverages are sold directly to the customer in a ready-to-consume state for consumption off site with no seats onsite. For the purposes of parking requirements, the ordering or take-out area is defined as the counter and the area between the counter and the main entry to the establishment.

"Retail Stores, General Merchandise, Limited" means ~~retail trade establishments selling lines~~ an establishment which offers the sale of a limited line of merchandise, that is generally necessary or desirable for everyday living or everyday business activities. Examples ~~of general retail~~ include small grocery stores offering primarily prepared or pre-packaged food and lines of merchandise include but are not limited to:

1. ~~Art supply;~~
2. ~~Antiques;~~
3. ~~Bakeries (retail only);~~
4. ~~Bicycles;~~
5. ~~Books;~~
6. ~~Candy~~ beverage items, small drugstores and variety stores;
7. ~~Clothing and accessories;~~
8. ~~Collectables;~~
9. ~~Fabrics and sewing supplies;~~
10. ~~Floral;~~
11. ~~Gifts (novelties and souvenirs);~~
12. ~~Hobby materials;~~
13. ~~Jewelry;~~
14. ~~Luggage and leather goods;~~
15. ~~Music stores;~~
16. ~~Office supplies and~~ small stationery;
17. ~~Sporting goods and equipment;~~
18. ~~Toys and games;~~
19. ~~Tuxedo and formalwear rental;~~
20. ~~Variety~~ , office supply stores, shops selling other small household goods, and walk-out retail stores;
21. ~~Video rentals and sales.~~ This classification excludes convenience stores.

"Retail Stores, General Merchandise" means retail trade establishments selling lines of merchandise. This classification excludes convenience stores. Examples of general retail stores and lines of merchandise include but are not limited to:

1. Art supply;

-
2. Antiques;
 3. Bakeries (retail only);
 4. Bicycles;
 5. Books;
 6. Candy stores;
 7. Clothing and accessories;
 8. Collectables;
 9. Fabrics and sewing supplies;
 10. Floral;
 11. Gifts (novelties and souvenirs);
 12. Hobby materials;
 13. Jewelry;
 14. Luggage and leather goods;
 15. Music stores;
 16. Office supplies and stationery;
 17. Sporting goods and equipment;
 18. Toys and games;
 19. Tuxedo and formalwear rental;
 20. Variety stores;
 21. Video rentals and sales.

"Reverse Vending Machine" means an automated mechanical device which accepts at least one or more types of empty beverage containers including, but not limited to aluminum cans, glass and plastic containers, and issues a cash refund or a redeemable credit slip. A reverse vending machine sorts, and processes containers mechanically provided that the entire process is enclosed within the machine. In order to accept and temporarily store all three container types in a proportion commensurate with their relative redemption rates, and to meet the requirements of certification as a recycling facility, multiple grouping of reverse vending machines may be necessary.

A bulk reverse vending machine is a reserve vending machine that is larger than fifty (50) square feet; is designed to accept more than one container at a time; and will pay by weight instead of by container.

S

"Satellite Dish Antenna or Satellite Antenna" means any device incorporating a reflective surface that is solid, open mesh or bar configured to form a shallow dish, cone, horn or cornucopia used to transmit and/or receive electromagnetic signals. This definition includes antennas that are sometimes called "SES," "TVRO," "TVBS," and "DBS."

"School: Elementary, Middle, or High" means an institution which offers instruction in the several branches of learning and study required to be taught in the public schools by the Education Code of the State of California.

"School, trade and vocational" means an establishment where training is received to learn a particular trade or craft that involves skilled labor. Trades and crafts include but are not limited to the various construction trades, auto mechanics, machining, HVAC installation/repair/maintenance and similar trades and crafts.

"Service Station" means any premises used for supplying gasoline and oil at retail, direct to the customer, including minor accessories and services for automobiles, but not including automobile repairs.

Setback. See "Yard."

"Self-Storage or Mini-Storage" means the storage, generally of furniture and/or other household items, in small individual units (typically 400 square feet or less) that are available for rental by the general public.

"Short-Term Rental Unit" or "Short-Term Rental" or "STR" means the use of a dwelling unit, including, without limitation, a single-family, two-family, or multiple-family dwelling unit, mobile home, or any portion of such dwellings, rented for occupancy for dwelling, lodging, or sleeping purposes for a period of 30 or fewer calendar days, counting portions of days as full calendar days.

Signs. For purposes of Section XI-10-24, Sign Regulations, of this Chapter, the following definitions shall apply:

1. **"Abandoned Signs"** means any sign used for advertising or other purposes where the business it advertised or the use or event it supported has ceased operation for or occurred more than ninety (90) days prior to the sign's posting.
2. **"Abate"** means to repair, replace, remove, destroy, or otherwise remedy the condition in violation of this Chapter.
3. **"A-Frame Sign"** means and includes a sign that is portable, is capable of standing without support or attachment, and folds open in the form of an "A" or "sandwich-board".
4. **"Ancillary services sign"** means a sign displaying ancillary services such as smog services, lotto, or that represent trade affiliations, such as credit card services, or other similar services and not for the purpose of displaying products being sold.
5. **"Approved Plastics"** means those materials specified in the U.B.C. Standard No. 52-1 which have a flame spread rating of 225 or less and a smoke density not greater than that obtained from the burning of untreated wood under similar conditions when tested in accordance with U.B.C. Standard No. 42-1 in the way intended for use. The products of combustion shall be no more toxic than the burning of untreated wood under similar conditions.
6. **"Architectural Sign"** means and includes a sign used for advertising purposes which constitutes an integral part of a roof or marquee and is designed with an intent and purpose to relate to the architectural style of the main building.
7. **"Area Identification Sign"** means and includes a permanent sign which serves to identify an area.
8. **"Awning sign"** means any sign or graphic attached to, painted on or applied to an awning or canopy.
9. **"Balloon Sign"** means and includes any large [over three (3) cubic feet in size] inflatable hot/cold air or helium balloon that is used as an advertising device for any business or promotional event.
10. **"Banner Sign"** means and includes a temporary sign composed of lightweight, flexible, non-rigid material either enclosed or not enclosed in a rigid frame.
11. **"Blade Sign"** means a pedestrian oriented sign, adjacent to a pedestrian walkway or sidewalk, attached to a building wall, marquee, awning, or arcade with the exposed face of the sign in a plane that is perpendicular to the plane of the building wall.
12. **"Building Perimeter"** means the total exterior wall length for any and all buildings intended for human occupancy, as measured at the ground elevation. No second story or subsequent upper story areas shall be considered as a part of this calculation.
13. **Canopy Sign.** See awning sign.

-
14. **"City Identification Sign"** means and includes a sign placed at the point of entry to the City of Milpitas for the purpose of informing a person that they are entering the City of Milpitas.
 15. **"Construction Sign"** means and includes a sign placed on the property where site work, building construction and/or a tenant improvement within an existing building is in progress. The sign may denote that a business will be opening soon, the opening date, names of the architect, engineer, contractor, future business and lending agency.
 16. **"Directional Sign"** means a sign which guides and directs motorists to a specified destination in the most direct manner possible.
 17. **"Display Surface"** means the area made available by the sign structure of building surface for the purpose of displaying the advertising message.
 18. **"Electric Sign"** means any sign containing electrical wiring, but not including signs illuminated by an exterior light source.
 19. **"Erect"** means to build, construct, attach, hang, place, suspend or affix.
 20. **"Exposed raceway"** means an enclosure or conduit that is used to conceal wiring for a lighted sign and is visible from any elevation, typically located between the sign and the building to which the sign is attached.
 21. **"Flag"** means a visual device with no commercial copy, usually rectangular in shape and made of a cloth material suspended by, or attached to, a pole or post and may be raised or lowered.
 22. **"Flag sign"** means a visual display device with commercial copy, usually rectangular in shape and made of a cloth material suspended by, or attached to, a post, or pole and may be raised and lowered.
 23. **"Freestanding Sign"** means a sign which is supported by one or more uprights, poles, or braces in or upon the ground, or partially supported and attached to any building, other structure, or foundation on the ground.
 24. **"Garage Sale Sign"** means a sign used primarily for the purpose of advertising a "garage sale" and/or "yard sale" at a residence.
 25. **"Grand Opening Sign"** means and includes banners, pennants, flags, balloons, and similar advertising devices when used only for bona fide grand-opening functions, new ownership, name change, or the reopening of a business that has completely closed for remodeling for at least two weeks.
 26. **Graphic Panel, Freestanding.** Freestanding graphic panel means a freestanding sign located within five feet of the main building wall, which relates to the architecture of the building and depends primarily on a graphic image for delivering its advertising message. Graphic panels do not count as freestanding signs. The display area on graphic panels counts towards overall sign area.
 27. **"Impact Resistive Plastic"** means any plastic material capable of resisting fifty (50) foot pounds of force as tested in accordance with ANSI/UL 972 Multiple Impact Test or any similar test procedure.
 28. **"Information Sign"** means and includes signs providing courtesy information, or direction to the public without advertising the business products, or services such as hours, entrance, exit, self-serve, credit cards, restrooms, telephone drive-up, or which serves to direct motorist and pedestrians on private property.
 29. **"Joint Use Sign"** means and includes a freestanding sign for a commercial district under multiple ownerships where freestanding signs for each parcel for which signage is desired is infeasible. The commercial district shall be characterized by close proximity of the businesses and small parcel size. A common parking field and common vehicular circulation are encouraged.

-
30. **"Logo"** means a trademark, or symbol of an organization which is registered with the federal or State government and consistently used in conducting the business activities of said organization.
 31. **"Marquee"** means a permanent roofed structure, attached to, and support by the building and projecting beyond the main building.
 32. **"Multi-use Structures"** means any commercial, industrial, quasi-public, or agricultural farm products sales use, containing five or more stores, or businesses on a single parcel of land.
 33. **"Mural"** means a display, or illustration painted on a building, or wall within a public view not intended to advertise a product, service, or business, and therefore is not considered a sign.
 34. **"Mural sign"** means a display, or illustration painted on a building, or wall intended to advertise a product, service, or business.
 35. **"Noncombustible Material"** means any material which will not ignite at, or below a temperature of one thousand two hundred (1,200) degrees during an exposure of five (5) minutes, and which will not continue to burn or glow at that temperature. Tests shall be made as specified in U.B.C. Standard No. 4-1.
 36. **"Nonstructural Trim"** means the molding, battens, capping, nailing strips, latticing, cutout, or letters and walkways which are attached to the sign structure.
 37. **"Off-site Advertising Display"** means any sign that advertises, or informs about a business organization, event, goods, products, services, or uses not available on the property upon which the sign is located.

The term "Off-site Advertising Sign" does not include Joint Use Sign, Temporary Tract Advertising Signs for subdivisions under construction in the City, Open House Directional Signs, Garage Sale Signs, Off-site Public Information Signs, off-site directional signs for purposes of identifying regional shopping centers, and Temporary Tract Advertising Signs.

38. **"Off-site Directional Sign"** means any sign that provides direction to retail, community, and cultural events not available on the property upon which the sign is located.

The term "Off-site Directional Sign" does not include Garage Sale Signs, Joint Use Signs, Official City or City-sponsored signs, Off-site Directional Signs identifying regional shopping centers, Off-site Public Information Signs, Open House Directional Signs, and Temporary Tract Advertising Signs.

39. **"Off-site Public Information Sign"** means a sign that is placed proximate to a major city entry on privately owned property that is used to provide non-advertising information and/or identification symbols or plaques to the public for civic organizations, service clubs or other quasi-public uses and is erected within the public right-of-way.
40. **"Open House Directional Sign"** means a sign, no larger than six (6) square feet in sign area per side, used primarily for the purpose of directing traffic to a house being offered for sale or lease.
41. **"Other Advertising Structure"** means any device erected or used for the same purpose as a sign, whether erected, or used:
 - a. Exclusively for advertising purposes, upon which any poster bill, printing, painting device, or other advertisement or identification of any kind whatsoever may be placed, posted, painted, fastened, or affixed.
 - b. Exclusively for advertising purposes and including any spectacle, display or advertising statuary.
42. **"Permanent Sign"** means every sign except temporary sign as defined herein.

-
43. **"Political Sign"** means a sign which is designated to influence the action of the voters, and election, or defeat of a candidate for the nomination, or election to any public office, or a measure appearing on the ballot at any national, state, district, or local election.
 44. **"Portable"** means an object that is capable of being borne or carried, easily transported, or conveyed without difficulty.
 45. **"Portable Sign"** means and includes a sign that is portable and capable of being borne, or carried, easily transported, or conveyed without difficulty, is capable of standing without support or attachment, is unattached to any structure, and is used for advertising purposes.
 46. **"Projection"** means the distance by which a sign extends over public property or beyond the building line.
 47. **"Projecting Sign"** means a sign other than a wall sign which projects from, and is supported by a wall of a building or structure.
 48. **"Public Information Sign"** means a sign erected for the sole purpose of displaying advertising for community activities and/or identification symbols or plaques for civic organizations or service clubs.
 49. **"Public Street Frontage"** means a publicly owned street immediately adjacent to the parcel, for purposes of sign area and height calculations. Public streets for which the parcel does not have access rights are not included for purposes of any sign calculations.
 50. **Raceway.** See "exposed raceway."
 51. **"Regional Shopping Center"** means any commercial development on one (1) or more parcels of land which are contiguous, or across from a right-of-way which contains a gross land area of at least thirty (30) acres or a gross building area of at least 200,000 square feet. Current regional shopping centers are McCarthy Ranch Marketplace, the Town Center shopping center, and the Great Mall and its out-parcels zoned General Commercial.
 52. **"Roof Sign"** means a sign erected upon or above a roof or a part of a parapet of a building or structure.
 53. **"Scoreboard Sign"** means a sign located on scoreboard structures located in an adult or youth outdoor playing field on public property and shall be for products or businesses available to persons of all ages.
 54. **"Shopping Center"** means any commercial development containing five (5) or more stores or businesses on one (1) or more parcels of land operating as an integrated use and having a gross parcel area of five (5) or more acres.
 55. **"Shopping Center Identification Sign"** means a sign located on the site of a shopping center or regional shopping center that states the name of the shopping center or regional shopping center.
 56. **"Sign"** means every announcement, declaration, demonstration, display, illustration insignia, surface, or space when erected or maintained out of doors in view of the general public for identification, advertisement or promotion of the interests of any person.
 57. **"Sign Area"** means the area of a sign to be calculated that includes all lettering, wording, and accompanying designs or symbols, together with any background of a different material or color than the remainder of the wall of the building to which is affixed or upon which it is painted. In the case of a freestanding sign, the supports or uprights on which any sign is supported should not be included in determining the sign area unless such supports or uprights are designed in a manner as to form an integral background of the sign.

Where the sign consists of individual letters or symbols, the area shall be considered to be that of the smallest rectangle, circle, square, or triangle which can be drawn to encompass all of the letters. Provided however, that where such individual type letters or symbols are separated more than thirty-six (36) inches from each other, those letters or symbols shall be calculated separately.

If the sign has more than one (1) advertising surface, the sum of all the areas of all such surfaces shall be the area of the advertising surface of such sign except that, if two (2) surfaces on the same face in opposite directions (i.e., the relative angles between the directions they face is one hundred eighty (180) degrees) and the distance between such two (2) surfaces is not more than twenty-four (24) inches, then the area of only one of the two surfaces (the largest if they are not equal) shall be included in the computation.

58. **"Sign Program"** means a specific set of design standards established for the purpose of unifying a variety of signs associated with a multitenant or multiuse project, building or complex of buildings.
59. **"Sign Surface"** means the surface of the sign upon, against or through which the message is displayed or illustrated.
60. **"Snipe sign"** means temporary or portable signs advertising events that are fastened to fences, trees, utility poles, or other structures or fixtures and also including signs on sticks stuck in the ground and usually found off-site. These do not include real estate, political or open house signs.
61. **"Statuary Sign"** means statuary used for advertising purposes or representing the logo of a business.
62. **"Temporary Sign"** means any sign, banner, flag, valance, pennant, streamer, whirligig or advertising display, constructed of cloth, canvas, fabric, cardboard, plywood or other light material with or without a frame, whether attached or portable, and designed or intended to be displayed for a short period of time.
63. **"Temporary Promotional Sign"** means any temporary Balloon Signs, banners, and similar advertising devices when used only for special promotional events.
64. **"Temporary Tract Advertising Sign"** means a uniformly designed sign which advertises a residential development.
65. **"Vehicle-Mounted Sign"** means a sign, used for the purpose of advertising, larger than three (3) feet by three (3) feet mounted on, attached to or capable of being borne or carried, easily transported or conveyed without difficulty by a vehicle, where that vehicle is parked on public or private property. This definition does not include signs on delivery vehicles in the act of making a delivery or signs on vehicles parked on residential driveways or public streets.
66. **"Wall Sign"** means any sign painted on, attached to or erected against the wall of a building or structure.
67. **"Window Sign"** means any sign painted, attached, glued or otherwise affixed to the interior or exterior surfaces of a window or suspended or located within three (3) feet of the window for the primary purpose of being visible from the exterior of the building.

"Single Household Unit" means the functional equivalent of a traditional family, whose members are a non-transient interactive group of persons jointly occupying a single dwelling unit, including the joint use of common areas which are not compartmentalized, such locked cabinets or doors. A single housekeeping unit shall be limited to one (1) kitchen and shall have permanent internal access to all rooms within the dwelling unit, except as provided for Accessory Dwelling Units.

"Single Room Occupancy (SRO) Residence" means a multi-tenant building consisting of single room dwelling units that are the primary residence of its occupants, containing either individual or shared kitchen and bathroom facilities. These units are small (generally less than 350 square feet), and provide a valuable source of affordable housing for individuals and can serve as an entry point into the housing market for formerly homeless people.

Slope. Same as "Natural Land Slope."

"Specific plan" means a detailed plan for the development of a specific area. Specific plans are a significant tool to implement the General Plan. A specific plan documents the proposed distribution, location, extent and intensity of major components of public and private transportation, sewage, water, drainage, solid waste disposal,

energy, parks and other essential facilities proposed to be located within or needed to support the land uses described in the plan, as well as implementation and financing methods and added benefits to the City as a whole.

Stable, Private. "Private stable" means a detached accessory building for the keeping of horses owned by the occupants of the premises and not kept for remuneration, hire or sale.

Stable, Public. "Public stable" means a stable other than a private stable.

"Story" means that portion of a building included between the surface of any floor and the surface of the floor next above it, or if there be no floor above it, then the space between such floor and ceiling next above it.

Story, Half. "Half story" means a story under a gable, hip or gambrel roof, the wall plates on which on at least two (2) opposite exterior walls are not more than four (4) feet above the floor of such story.

"Street" means a permanently reserved thoroughfare which affords principal means of access to abutting property.

"Structure" means anything constructed or erected, which requires location on the ground or is attached to something having a location on the ground.

"Supportive Housing" means housing with no limit on length of stay, that is occupied by the target population as defined in Section 11302 of Title 42 of the United States Code, as may be amended, and that is linked to onsite or offsite services that assist the supportive housing resident in retaining the housing, improving his or her health status, and maximizing his or her ability to live and, when possible, work in the community as defined in the California Health and Safety Code Section 50801(e), as may be amended.

T

"Thrift Store" means any profit or nonprofit business, organization, group or otherwise that engages in or specializes in the sale or resale of previously owned or used goods and merchandise from an area greater than 25 percent of the total floor area devoted to retail sales and whose goods and merchandise are donated or primarily donated. A specialty retail store that sells used goods or merchandise not donated for sale, including but not limited to used record stores, used book stores, used furniture stores, and sports trading card stores, shall not be considered a thrift store for the purpose of this Chapter.

"Townhouses" means dwelling units that are attached at their sides in groups of three or more and are sited on individual lots with vehicular access from driveways. Private rear yards or patios and common open space may be part of a townhouse development.

Trailer, Automobile. "Automobile trailer" means a vehicle without motive power designed to be drawn by a motor vehicle and to be used for human habitation or for carrying persons and property, including a trailer coach or house trailer.

"Transitional Housing" means buildings configured as rental housing developments, but operated under program requirements that call for the termination of assistance and recirculation of the assisted unit to another eligible program recipient at some predetermined future point in time, which shall be no less than six months as defined in the California Health and Safety Code Section 50801(e), as may be amended.

"Tri-laminate Asphalt Composition" means an asphalt composition roof material that is comprised of three layers of tile adhered together to create one shingle and when installed overlap with another row of three-layered tile for a total minimum thickness of $\frac{7}{8}$ inches.

"Tutoring Centers" means facilities offering academic instruction to individuals or groups in a classroom setting.

"Two-unit Project" means the development of two primary dwelling units or, if there is already a primary dwelling unit on the lot, the development of a second primary dwelling unit on a legally subdivided lot.

U

"Unreasonable Period of Time" means not less than thirty (30) calendar days following notification by the City to the owner/occupant pursuant to this Chapter that the property is in violation of this Chapter. The City Manager, upon a finding that the violation in question constitutes a threat to the health and safety of any person may designate a time period of thirty (30) calendar days or less upon notice to the owner/occupant to abate the nuisance. Prior notice shall not be required for summary abatement pursuant to this Chapter.

"Urban Lot Split" means the subdivision of an existing, legally subdivided lot into two lots.

"Usable Open Space" means any open space, the smallest dimension of which is at least six (6) feet and which is not used as storage or for movement of motor vehicles. Yards abutting a public street, which are not adequately screened for privacy, in the opinion of the Planning Commission, shall not qualify as usable open space.

"Use" means the purpose for which land or a building is arranged, designed or intended, or for which either land or building is or may be occupied or maintained.

V

"Video Sales and Rental Store" means any place of business which includes the sale or rental of prerecorded video tapes, laser discs, compact discs, or any other medium which projects pictures on a screen.

W

"Warehousing and Distribution" means a facility, primarily within an enclosed building, for the storage of commercial or industrial goods, products and materials and the associated on-site sorting, packing, staging, shipping, receiving, and distributing of goods to wholesale and retail outlets, including ancillary truck parking and dispatching. Also includes long-term, passive storage of furniture, household goods, or other commercial goods; and of industrial equipment, products, and materials. Warehousing and distribution facilities may include, but are not limited to, wholesale distribution, distribution centers, moving and transfer storage, cross-dock facilities, package handling centers, order fulfillment centers, and logistics centers. Excludes storage of raw materials and/or finished products as part of an active primary use such as General Manufacturing, Advanced Manufacturing, or Research and Development. Excludes Parcel Hubs.

Wireless Communications Facilities Definitions. For the purposes of wireless communications facilities, the following definitions shall apply:

1. **"Commercial Wireless Communication Facility"** means a wireless communication facility operated by a for-profit business or for-profit purposes. See by contrast, "Noncommercial wireless communication facility."
2. **"Noncommercial Wireless Communication Facility"** means a wireless communication facility operated by a government agency, a nonprofit organization, a for-profit business for nonprofit purposes or a private citizen for personal use. It includes all amateur radio facilities. See by contrast, "Commercial wireless communication facility."
3. **"Stealth Wireless Communications Facility"** means any antenna designed to be architecturally integrated into a building that is architecturally consistent with the building design. Examples include a steeple, cupola or tower element on a building and do not include flag poles, monopoles or other structures designed to house antenna and resemble natural features.
4. **"Wireless Communication Facility"** means the equipment and associated structures needed to transmit and/or receive electromagnetic signals. A wireless communication facility typically includes antennas, supporting structures (including, but not limited to, monopoles, utility structures, buildings and accessory structures), enclosures and/or cabinets housing associated equipment, cable, access roads and other accessory development.

"Wholesale Sales" means the selling and/or distributing of merchandise to retailers; industrial, commercial, or institutional buyers; or other wholesalers; or acting as agents or brokers in the buying and selling of merchandise to or for such entities.

Y

"Yard" means an open space, other than a court, on a lot, unoccupied and unobstructed, except by eaves, from the ground upward, except as otherwise provided in this Chapter. Where applicable, yards shall be measured perpendicularly from the property line to the face of the nearest exterior wall of any main building, except as otherwise provided in this Chapter (See Subsection XI-10-55.04-11). Setback shall be synonymous with yard.

Yard, Front. "Front yard" means a yard extending across the full width of the lot, the depth of which is the minimum horizontal distance between the front lot line and a line parallel thereto on the lot.

Yard, Rear. "Rear yard" means a yard extending across the full width of the lot between the most rear main building and the rear lot line; the depth of the required rear yard shall be measured horizontally from the nearest point of the rear lot line toward the nearest exterior wall of the main building.

Yard, Side. "Side yard" means a yard between the main building and the side lot line extending from the front yard, or front lot line where no front yard is required, to the rear yard; the width of the required side yard shall be measured horizontally from the nearest point of the side lot line toward the nearest exterior wall of the main building.

Z

Zone. See "district."

(Ord. No. 38.848 , § 4, 11/15/22; Ord. No. 38.846 , § 4, 10/19/22; Ord. No. 38.847 , § 5, 8/16/22; Ord. No. 38.844 , § 4, 12/14/21; Ord. No. 38.841 , § 4, 5/4/21; Ord. No. 38.835 , § 4, 3/3/20; Ord. No. 38.839 , §§ 4, 5, 12/3/19; Ord. No. 38.837 , § 4, 11/5/19; Ord. No. 38.836 , § 4, 9/3/19; Ord. No. 38.833 , § 4, 5/7/19; Ord. No. 38.823 , § 3, 11/17/15; Ord. No. 38.816 , § 3, 9/2/14; Ord. No. 38.813 , § 2, 4/1/14; Ord. No. 38.810 , § 3, 12/3/13; Ord. No. 38.808 , § 2, 5/21/13; Ord. No. 38.803 , §§ 2—5, 4/17/12; Ord. No. 38.793 , § 2, 5/17/11; Ord. No. 38.788 , §§ 4—6, 9/7/10; Ord. No. 38.795 , §§ 3—15, 4/6/10; Ord. No. 38.792 , § 2, 8/4/09; Ord. No. 38.789 , §§ 2—7, 4/21/09; Ord. No. 38.785 , § 2, 4/7/09; Ord. 38.780 (2) (part), 8/19/08)

Section 3 Zoning Districts

XI-10-3.01 Districts

In order to carry out the purpose and provisions of this Chapter, the City is hereby divided into districts known as:

Full Name	Short Name
"R1" Single-Family District	"R1" District
"R2" One and Two-Family District	"R2" District
"R3" Multiple-Family District	"R3" District
<u>"R3-Metro" Metro Multi-Family High Density Residential District</u>	<u>"R3-Metro" District</u>
"R4" Multiple Family Very High Density District	"R4" District
<u>"R4-Metro" Metro Multi-Family Very High Density Residential District</u>	<u>"R4-Metro" District</u>
"R5" Urban Residential <u>District</u>	"R5" District
<u>"R5-Metro" Metro Urban Residential District</u>	<u>"R5-Metro" District</u>
"AR" Agricultural Residence <u>District</u>	"AR" District
"CO" Administrative and Professional Office District	"CO" District
"C1" Neighborhood Commercial District	"C1" District
"C2" General Commercial District	"C2" District
"HS" Highway Service District	"HS" District
"TC" Town Center District	"TC" District
"MXD" Mixed Use District	"MXD" District
"MXD2" High Density Mixed Use District	"MXD2" District
<u>"MXD2-Metro" Metro High Density Mixed Use District</u>	<u>"MXD2-Metro" District</u>
"MXD3" Very High Density Mixed Use District	"MXD3" District
<u>"MXD3-Metro" Metro Very High Density Mixed Use District</u>	<u>"MXD3-Metro" District</u>
"M1" Light Industrial District	"M1" District
"M2" Heavy Industrial District	"M2" District
"MP" Industrial Park District	"MP" District
<u>"BPRD" Business Park Research and Development District</u>	<u>"BPRD" District</u>
<u>"BPRD-Metro" Metro Business Park Research and Development District</u>	<u>"BPRD-Metro" District</u>
<u>"BPRD-R-Metro" Metro Business Park Research and Development, Limited Residential District</u>	<u>"BPRD-R-Metro" District</u>
"A" Agricultural District	"A" District
<u>"I" Institutional District</u>	<u>"I" District</u>
"POS" Park and Open Space District	"POS" District
"PD" Planned Development District	"PD" District

(Ord. 38.814, § 3, 4/15/14; Ord. 38.777 (4), 6/17/08; Ord. 38.759 (part), 4/2/02; Ord. 38.733 (part), 1/6/98; Ord. 38 (part), 3/15/55)

XI-10-3.02 Combining Regulations

In addition to the foregoing district certain combining regulations are established as set forth in this Chapter, said combining regulations being as follows:

Full Name	Short Name
"HR" High Rise Overlay District	"HR" District
"H" Hillside Combining District	"H" District
"MHP" Mobile Home Park Combining Overlay District	"MHP" District
"OO" Gateway Office Overlay Combining District	"OO" District
"RE" Recreation & Entertainment Overlay District	"RE" District
"S" Site and Architectural Overlay District	"S" District
"TOD" Transit Oriented Development <u>Overlay</u> District	"TOD" District
"FC" <u>Freeway Corridor Overlay</u> District	"FC" <u>District</u>

(Ord. No. 38.795, § 16, 4/6/10; Ord. 38.782(1), 12/16/08; Ord. 38.776(3), 3/18/08; Ord. 38.761 (part), 5/20/03; Ord. 38.759 (part), 4/2/02; Ord. 38.663(B) (part), 8/20/91; Ord. 38 (part), 3/15/55)

XI-10-3.03 Zoning Map

The districts aforesaid and the boundaries of such districts are shown upon the map attached hereto and made a part of this Chapter, being designated as the "Zoning Map of the City of Milpitas," together with "Sectional District Map of the City of Milpitas" supplementary thereto, consisting of an "Index Map" to sectional district maps numbered consecutively, and said map and all notations, references and other information shown thereon shall be as much a part of this Chapter as if the matters and information set forth by said map were all fully described herein.

(Ord. 38.777 (5), 6/17/08; Ord. 38 (part), 3/15/55)

XI-10-3.04 Letter Designation Includes All Aspects of the Zone

Whenever the terms "R" District, "C" District or "M" District are used herein, they shall be deemed to refer to all districts containing the same letter in their names; for example, the term "C" District shall include the "C1" and "C2" District.

(Ord. 38 (part), 3/15/55)

XI-10-3.05 Most Restrictive and Least Restrictive Zones

The "R1" District is the most restrictive and the "M2" District is the least restricted.

(Ord. 38 (part), 3/15/55)

XI-10-3.06 Reference to General Provisions and Exceptions

For "General Provisions" and "Exceptions" pertaining to the following district regulations, see Sections 54 and 55 inclusive.

(Ord. 38 (part), 3/15/55)

Section 7 Industrial Zones and Standards

XI-10-7.01 Purpose and Intent

- A. Light Industrial (M1) Zone. The M1 Light Industrial District is reserved for the construction, use and occupancy of buildings and facilities for office, research, limited and light manufacturing, and other uses compatible with the district.
- B. Heavy Industrial (M2) Zone. The M2 Heavy Industrial District is reserved for the construction, use, and occupancy of buildings and facilities for office, research, general manufacturing, warehousing and distribution and other uses compatible with the district.
- C. Industrial Park (MP) Zone. The MP District is intended to accommodate, in a park-like setting, a limited group of research, professional, packaging and distribution facilities and uses which may have unusual requirements for space, light, and air, and the operation of which are clean and quiet and which meet the standards set herein.
- D. Business Park Research and Development (BPRD) Zone. The purpose of the BPRD District is to designate specific areas of the city as important employment centers, especially for jobs in the hightech industry. The BPRD zone is intended to accommodate business parks, high-intensity office buildings, advanced manufacturing, and other light industrial uses, and to enable the integration and growth of research and development, office, small warehouse, and light manufacturing uses on consolidated sites with supportive ancillary uses such as restaurants, health/fitness centers, limited retail, and child care facilities.

(Ord. No. 38.803, § 8, 4/17/12; Ord. No. 38.789, § 9, 4-21-09)

XI-10-7.02 Industrial Use Regulations

- A. Permitted and Conditionally Permitted Uses.
 - 1. Primary uses. The uses identified in Table XI-10-7.02-1, Industrial Zone Uses, shall be the primary uses allowed to occur on a property. All uses except for those noted shall be conducted within enclosed structures. The primary uses identified in Table XI-10-7.02-1 shall be permitted or conditionally permitted, as indicated:

P	Where the symbol "P" appears, the use shall be permitted.
MCS	Where the symbol "MCS" appears the use shall be permitted subject to the issuance of a Minor Conditional Use Permit <u>by staff</u> , in accordance with Subsection XI-10-57.04, Conditional Use Permits and Minor Conditional Use Permits, of this Chapter.
C	Where the symbol "C" appears, the use shall be permitted subject to the issuance of a Conditional Use Permit, in accordance with Subsection XI-10-57.04, Conditional Use Permits and Minor Conditional Use Permits, of this Chapter.
MC	Where the symbol "MC" appears, the use shall be permitted subject to the issuance of a Minor Conditional Use Permit <u>by the Zoning Administrator</u> , in accordance with Section <u>Subsection XI-10-57.04</u> , Conditional Use Permits and Minor Conditional Use Permits, of this C chapter.
O	Where the symbol "O" appears, the use is subject to an alternative review process described in a subsequent footnote.

2. In the BPRD zone, all uses and activities must take place within an enclosed building.
3. Accessory Uses. The following accessory uses are allowed when incidental to the primary use:
 - a. In M1 and MP zones, incidental services, such as restaurants and recreation facilities for employee use only and when conducted in and entered from within the building or campus.
 - b. Cafeterias may be permitted when ancillary to a primary use and associated with business or industrial uses.
 - c. Banquet halls may be permitted with a Conditional Use Permit, in accordance with Section XI-10-57.04, when ancillary to convention centers, hotels or motels.
 - d. In the BPRD, business support services, convenience retail, commercial athletic facilities, child care centers, and restaurants with or without on-site service of alcohol.

- B. Prohibited Uses. The following uses are prohibited:
1. Uses where the symbol "NP" appears within Table XI-10-7.02-1.
 2. Uses that have been excluded from Table XI-10-7.02-1, unless they are found by the City to be similar to permitted or conditionally permitted uses in accordance with C below.
- C. Other Uses. Any other uses may be considered by the Planning Commission that are similar in accordance with the procedure prescribed in Subsection 10-54.02, Other Uses Permitted by Commission, of this Chapter.

**Table XI-10-7.02-1
Industrial Zone Uses**

Use	M1	M2	MP	BPRD
1. Commercial Uses				
<u>Alcoholic beverage sales</u>	<u>NP</u>	<u>NP</u>	<u>NP</u>	<u>C¹</u>
Adult businesses ^{4,2}	P	NP	NP	<u>NP</u>
Business support services	P	NP	P	<u>MCS¹</u>
<u>Convenience store</u>	<u>C</u>	<u>NP</u>	<u>C</u>	<u>NP</u>
Furniture repair and reupholstery	P	NP	NP	<u>NP</u>
<u>Grocery store</u>	<u>NP</u>	<u>NP</u>	<u>NP</u>	<u>NP</u>
Personal services	C	NP	C	<u>C</u>
Printing (newspaper, blueprint, publishing)	P	NP	C	<u>MC</u>
Repair and cleaning, small items	P	NP	NP	<u>NP</u>
<u>Retail, limited</u>	<u>C</u>	<u>NP</u>	<u>C</u>	<u>MCS¹</u>
Retail stores, general merchandise ²	C	NP	C	<u>NP</u>
2. Entertainment and Recreation Uses				
Billiards	C	NP	C	<u>NP</u>
Commercial athletic facilities	C	NP	C	<u>MCS^{1,3}</u>
3. Health and Veterinarian Uses				
Hospitals	NP	NP	C	<u>NP</u>
Kennel	P	NP	NP	<u>NP</u>
Medical support laboratories	P	NP	P	<u>MC</u>
Medical and dental offices and clinics ²	P	NP	P	<u>MC</u>
Veterinarian hospital	P	NP	P	<u>NP</u>
4. Industrial Uses				

Use	M1	M2	MP	BPRD
<u>Advanced manufacturing</u>	<u>P</u>	<u>P</u>	<u>P</u>	<u>P</u>
Assembly from pre-processed materials ³⁴	P	P	P	<u>P</u>
Auto assembly facility	NP	P	NP	<u>MCS⁵/NP</u>
Bottling facility	P	P	NP	<u>NP</u>
Building material sales (equipment rental) ⁴⁵	NP	C	NP	<u>NP</u>
Commercial fueling facility	C	C	NP	<u>NP</u>
Commercial laboratory	P	P	P	<u>P</u>
Contractor's yard and offices ⁴ shop ⁶	NP	C <u>P</u>	NP	<u>C</u>
<u>Custom and artisan manufacturing</u>	<u>P</u>	<u>MCS</u>	<u>P</u>	<u>MCS</u>
<u>Data centers</u>	<u>P</u>	<u>NP</u>	<u>P</u>	<u>P</u>
Distribution facility	P	P	P	
Dry-cleaning plant	P	P	NP	<u>NP</u>
Film processing, photo finishing and printing, etching, lithography, printmaking, and other similar creative industries	P	MCS	P	<u>MCS</u>
Freight and trucking yard ⁴⁵	NP	P	NP	<u>NP</u>
Mini-storage complex or self storage	C	C	NP	<u>NP</u>
<u>Parcel hub</u>	<u>P</u>	<u>MCS</u>	<u>P</u>	<u>C</u>
Plumbing, metalworking, glassworking or woodworking	P	P	NP	<u>C</u>
Plant or facility (research & development , assembly of goods, manufacturing, packaging, processing, repairing, etc. or materials, merchandise or products)	P	P	P	<u>MC</u>
Pottery or tile manufacturing	P	P	NP	<u>C</u>
Recycling processing facility	C	C	NP	<u>NP</u>
<u>Research and development</u>	<u>P</u>	<u>MCS</u>	<u>P</u>	<u>P</u>
Soils and materials testing laboratories	P	P	P	<u>P</u>
Warehousing and wholesale distribution	P	P	P	<u>P/C⁷</u>
<u>Wholesale sales</u>	<u>P</u>	<u>P</u>	<u>P</u>	<u>P</u>
5. Lodging Uses				
Hotels/motels	C	NP	C	<u>NP</u>
6. Professional Office Uses				
Offices, business and professional	P	NP	P	<u>P</u>
Financial institutions (banks, savings and loans, etc.)	C	NP	P	<u>NP</u>
7. Public, Quasi-Public and Assembly Uses				
Auditorium ⁵⁸	NP	NP	C	<u>NP</u>
<u>Child care center</u>	<u>NP</u>	<u>NP</u>	<u>C¹</u>	<u>MCS¹</u>
Conference center ⁵⁸	NP	NP	C	<u>MCS</u>
<u>College and university, public or private⁹</u>	<u>NP</u>	<u>NP</u>	<u>NP</u>	<u>C</u>
Vocational school	C	NP	C	<u>C</u>
Farmer's market (not including flea market) ⁶¹⁰	NP	NP	C	<u>MC</u>

Use	M1	M2	MP	BPRD
Public utilities ^{7,11}	P	P	P	<u>NP</u>
Transportation facility (taxi, parcel service, armored car, etc.) ^{4,6}	NP	P	NP	<u>NP</u>
Temporary Public Safety Uses ^{8,12}	C	C	C	<u>NP</u>
Places of assembly ^{9,13}	C	NP	C	<u>NP</u>
8. Residential Uses				
Caretaker's residence	C	C	NP	<u>NP</u>
9. Restaurants or Food Service Uses				
Catering establishment	P	NP	P	<u>MC</u>
Restaurants				
With on-site service of alcohol	C	NP	C	<u>C¹</u>
Without on-site service of alcohol	C	NP	C	<u>MCS¹</u>
With live entertainment/dancing	NP	NP	NP	<u>NP</u>
Drive-in or drive-thru	C	NP	C	<u>NP</u>
Mobile Food Vending (individual vehicle) ^{10,14}	P	P	P	<u>P</u>
Mobile Food Park	NP	NP	NP	<u>NP</u>
Commissary	P	NP	P	<u>MC</u>
10. Vehicle Related Uses				
Auto junk yard ^{4,6}	NP	C	NP	<u>NP</u>
Auto repair (tire, oil change, smog check, etc.) ^{14,15}	C	P	<u>C^{12,16}</u>	<u>NP</u>
<u>Mobile Fueling¹⁷</u>	<u>P/C</u>	<u>P/C</u>	<u>P/C</u>	<u>P/C</u>
Service stations (with or without repair or retail) ^{14,15}	C	C	C	<u>NP</u>
With car wash	NP	C	C	<u>NP</u>
Vehicle sales and rental (auto, RV and truck-new and used in operable condition) ^{13,18}	C	C	<u>C^{12,16}</u>	<u>NP</u>
Auto broker (wholesale, no vehicles on site) ^{9,13}	MCS	MCS	MCS	<u>NP</u>

Notes:

¹ Limited to accessory uses that support primary employment-generating uses on the same site. Accessory commercial uses such as restaurants and convenience retail shall be located on the ground floor and in an area of the development where they can be directly accessed by the public.

² In accordance with the Title III, Chapter 4, Adult Business Ordinance and Subsection XI-10-13.04, Adult Businesses, of this Chapter.

~~When found necessary to serve and appropriate to the industrial area.~~³ Maximum 8,000 gross square feet in size.

⁴ Assembling, packaging, or distribution from previously prepared materials, such as cloth, plastic, paper, leather, precious or semi-precious metals or stones, electric or electronic instruments and devices such as television, radios, and pharmaceutical products.

⁵ Consistent with the intent and purpose of the BPRD Zone to support emerging industries within the high-tech sector, manufacturing and assembling of electric vehicles and other zero-emission vehicles, and/or component parts for such vehicles, may be permitted in this zone through approval of a Minor Conditional Use Permit in accordance with Subsection 57.04 of this Chapter. Manufacturing and assembling of conventional and hybrid vehicles with internal combustion engines, as a higher-intensity industrial use, is not permitted in the BPRD Zone.

⁶ When conducted wholly within a completely enclosed building or within an area enclosed on all sides with a solid wall or fence (e.g., chain link with slats) not less than eight feet in height.

⁷ Warehousing and distribution facilities up to 150,000 square feet are permitted in the BPRD Zone. Warehousing and distribution facilities that exceed 150,000 square feet may be allowed through the approval of a Conditional Use Permit, in accordance with Subsection 57.04 of this Chapter. In addition to the general required findings for a Conditional Use Permit, the following special finding must be made for

approval to be granted for a warehousing and distribution facility greater than 150,000 square feet: That the proposed use will support the continued operations and/or growth of business in the high-tech sector, contributing to economic activity and employment opportunities in the Business Park Research and Development Zone.

- ⁸ Shall be ancillary to the primary use or associated with business or industrial uses.
- ⁹ State has authority over permitting process regarding public facilities.
- ¹⁰ Refer to Subsection XI-10-13.10, Farmers Markets, of this Chapter.
- ¹¹ Includes service facilities, electric transmission and distribution substations and public utility service centers.
- ¹² See Subsection XI-10-13.11(I), Temporary Public Safety Uses.
- ¹³ See Subsection XI-10-7.04(A)(1), Industrial Zone Special Development and Performance Standards.
- ¹⁴ Refer to Subsection XI-10-13.18, Mobile Food Vending, of this Chapter.
- ¹⁵ Entrances to the services bays shall not be open to the street, but shall be so designed to face the rear or interior side property line.
- ¹⁶ Within MP zones, rental and repair may be considered only when ancillary to new auto dealerships.
- ¹⁷ Mobile fueling is permitted when fueling service is ordered by an individual vehicle owner and the amount of fuel dispensed as part of any individual order does not exceed 50 gallons. Mobile fueling for fleet vehicles may be permitted subject to approval of a Conditional Use Permit. Refer also to the California Fire Code as amended by the City of Milpitas Municipal Code, Title V, Chapter 300.
- ¹⁸ Within MP zones, boat and camper sales are prohibited. Dealerships shall be on property at least three acres or greater in area.

(Ord. No. 38.837 , §§ 7, 8, 11/5/19; Ord. No. 38.836 , § 5, 9/3/19; Ord. No. 38.827, § 2, 2/21/17; Ord. No. 38.803, § 8, 4/17/12; Ord. No. 38.795, §§ 24, 25, 4/6/10; Ord. No. 38.789, § 9, 4/21/09)

XI-10.7.03 Industrial Zone General Development Standards

A. The following minimum or maximum requirements shall be observed.

**Table XI-10-7.03-1
Industrial Zone Development Standards**

Standard	M1	M2	MP	<u>BPRD</u>
Lot Area, minimum	None	None	Individual sites shall be of such size to that all space requirements in this table are satisfied.	<u>25,000 sq. ft.</u>
Lot Width, minimum	None	None	100 ft.	<u>100 ft.</u>
Front Yard Setback, minimum	Along major street: 35 ft. from face of curb. Along non-major street: 25 ft. from face of curb.	Along major street: 35 ft. from face of curb. Along non-major street: 25 ft. from face of curb.	35 ft.	<u>10 ft.</u>
Side Yard Setback (interior), minimum	None	None	10 ft.	<u>None; 20 ft where abutting an R zone</u>

Standard	M1	M2	MP	BPRD
Street Side Yard Setback, minimum	Same as front yard setback	Same as front yard setback	Same as front yard setback	<u>Same as front yard setback</u>
Rear Yard Setback, minimum	None	None	20 ft.	<u>None; 20 ft where abutting an R zone</u>
Building Height, maximum	None. However, prior to construction of any structure that exceeds three (3) stories or thirty-five (35) feet in height, the Planning Commission must make the following finding: That any such excess height will not be detrimental to the light, air or privacy of any other structure or use currently existing or anticipated.			<u>80 ft/5 stories</u>
<u>Parking Setback from street-facing property line, minimum</u>	<u>None</u>	<u>None</u>	<u>None</u>	<u>Surface parking: 25 ft</u> <u>Truck or bus parking: 40 ft</u>
Parking	Refer to Section 53, Off Street Parking, of this Chapter.			
Floor Area Ratio	0.40 <u>Maximum</u>	0.40 <u>Maximum</u>	0.50 <u>Maximum</u>	<u>Minimum 0.35</u> <u>Maximum 2.5</u>
Landscaping	Refer to Subsection 7.03(B)			

- B. Areas of Lot Required to be Landscaped. Landscaped areas shall mean any area planted with plant material (trees, shrubs, ground cover, etc.). Landscape areas shall be exclusive of parking and vehicular traffic area (direct driveways excepted) and this shall be shown on the site plan in detail for Planning Commission approval.

The following areas shall be landscaped:

1. Required front yard area.
2. Required street side yard area.

This may be adjusted, by the Planning Commission, if it is found that adequate landscaping adjacent to the building(s) is provided to compensate for a reduction.

- C. Fences, Hedges and Walls. All planting, fencing and walls for new development, including but not restricted to fences and walls along rear and interior side property lines shall be approved by the Planning Commission. Modifications regarding landscaping, fencing and walls at existing developed sites shall be subject to the provisions of Subsection 54.10, Fences and Walls, of this Chapter.
- D. Utilities. All wires, pipes, cables and utility connections shall be placed in underground or subsurface conduits. All above ground transformers and vaults for new development shall be adequately screened to the approval of the Planning Commission. Modifications regarding subsurface conduits or above ground transformers and vaults at existing developed sites shall be subject to the provisions of Subsection 54.16, Trash Enclosures, Equipment and their Screening, of this Chapter.
- E. Areas for Collecting and Loading Recyclable Materials. There shall be provided areas for collecting and loading recyclable materials in accordance with the requirements of Subsection 54.12, Areas for collecting and loading recyclable materials, of this Chapter.
- F. Legal Nonconforming projects. Existing developments lawful at the time of installation or improvements which have been approved and a building permit issued prior to June 17, 1982, and installed in conformance with said approval and permit are considered legal nonconforming projects.

(Ord. No. 38.803, § 8, 4/17/12; Ord. No. 38.789, § 9, 4-21-09)

XI-10-7.04 Industrial Zone Special Development and Performance Standards

- A. Performance Standards. For uses requiring approval of a Minor Conditional Use Permit by staff, in accordance with Section XI-10-57.04, Conditional Use Permits and Minor Conditional Use Permits, of this Chapter, the following performance standards shall be met.
1. Auto Brokers. Auto Brokers may be permitted by right if the following standards are met:
 - a. Local Sales and Use Tax. In order to assist the City of Milpitas in its efforts to receive direct distribution of the local tax on materials associated with the project, the California Sales and Use Tax (the "Local Tax") shall be allocated to the project site, to the extent reasonably possible. Evidence of tax allocation or cause as to why such allocation cannot be made shall be submitted at the time of business license submittal.
- B. Special Development Standards in All Industrial Zones.
1. Abutting any R District. Where any ~~M~~Industrial District abuts any R District, there shall be provided 100 feet between any ~~M~~building on an industrially zoned parcel and the nearest property line of any R District. Applicants are advised that mitigating improvements may be needed to eliminate any adverse impacts from the residences and that additional requirements may be imposed on the developer to remedy the situation.
 2. Outdoor Storage. Outdoor storage for such things as trash and materials shall be permitted only when said storage areas are suitably screened with a solid wall or tight board fence and are located at least 100 feet from any R District and not within any required front or street side yard. Said location and screening of outdoor storage areas shall be to the approval of the Planning Commission. Modifications regarding outdoor storage at existing developed sites shall be subject to the provisions of Subsection 54.16, Trash Enclosures, Equipment and their Screening, of this Chapter.
 3. Places of Assembly. Places of Assembly are prohibited in the ~~M2~~Heavy Industrial (M2) Zone and Business Park Research and Development (BPRD) Zone. When any place of assembly use is established in an M1 or MP zone after the effective date of this Ordinance, such use shall be subject to the following requirements:
 - a. Applicant shall submit a review of potential hazardous site conditions and potential exposure of site users to these conditions. At a minimum, a Phase I Environmental Site Assessment (ESA) shall be performed for each proposed assembly use within the City's Light Industrial (M1), and Industrial Park (MP) zoning districts. Each individual project shall comply with the recommendations of the Phase I Environmental Site Assessment (which may include conducting Phase II sampling and implementing the recommendations of the Phase II ESA that may include cleanup of hazardous materials) and demonstrate that exposure of site users to hazardous materials conditions would be below established thresholds prior to approval of the Conditional Use Permit. In addition, an Accidental Release Assessment (ARA) shall be performed for each proposed assembly use within the City's Light Industrial (M1) and Industrial Park (MP) zoning districts to determine if unacceptable safety risks may result from the proposed change in use. The ARA shall review and evaluate any and all Risk Management Plans prepared for facilities in the vicinity under the California Accidental Release Prevention (CalARP) program. The environmental professional preparing the ARA shall determine, based on Alternative Release Scenarios, whether the proposed new assembly use would result in unacceptable safety risks due to proximity of uses handling or emitting acutely hazardous materials. If unacceptable risks are identified, the proposed use shall not be allowed.
 - b. Applicant shall submit a further noise study. The noise study shall demonstrate that ambient noise conditions within the vicinity of the proposed assembly use do not exceed the City's "normally acceptable" Noise Compatibility Standard of 70 dBA Ldn. In the event that existing
-

conditions exceed the "normally acceptable" standard the proposed assembly use may be required to install noise insulating materials to achieve the interior noise standard. Also as a condition of approval, proposed assembly uses shall be required to sign a disclosure of acknowledgment that they agree to operate within an existing industrial area and may be subject to noise levels that exceed the City of Milpitas's Noise Compatibility Standards for noise-sensitive uses.

- c. No assembly use shall install or otherwise use exterior public address systems or other noise generating equipment that exceeds the 70 dBA noise standard.
 - d. No new structure shall be construed within the M1 or MP zoning district for use as a place of assembly and no more than 50% of the square footage of any existing structure within the M1 or MP zoning district shall be converted to use as a place of assembly.
 - e. No exterior modifications to any existing structure within the M1 or MP zoning district shall be permitted if such modifications would materially alter the structure's appearance or future use as an industrial building.
- C. Special Development Standards in the MP Zones and BPRD zones.
- 1. Uses in the District MP and BPRD zones shall ~~be such those they~~:
 - a. Emit no obnoxious, toxic or corrosive fumes or gases.
 - b. Emit no odors perceptible at the property line.
 - c. Emit no smoke. This does not preclude the use of backup or emergency generators.
 - d. Discharge into the air no dust or other particular matter created by any industrial operations or emanating from any products stored prior or subsequent to processing.
 - e. Produce no heat or glare perceptible beyond the lot boundaries.
 - f. Utilize all lighting in a manner which produces no glare on public streets or on any other parcel.
 - g. Produce no physical vibrations perceptible at or beyond the lot boundaries.
 - h. Produce no electromagnetic radiation or radioactive emission injurious to human beings, animals or vegetation, except under controlled operations being conducted observing standards or methods or operation established by the Nuclear Regulatory Commission. Electromagnetic radiation or radioactive emissions shall not be of an intensity that interferes with the use of any other property.
 - i. Do not engage in the production or storage of any material designed for use as an explosive, or in the use of such material in production.
 - j. Indicate that all industrial uses shall use only gas, electricity, or preheated oil as a fuel; provided, however, that oil-burning equipment may be installed for stand-by emergency use only.

XI-10-7.05 Special Design Standards for the BPRD Zone

A. Building Entrances.

- 1. At least one building entrance must be provided along the primary street frontage.
- 2. The primary building entrance must incorporate a projection, recess, or combination of projection and recess at least 40 square feet in area and with a minimum depth of five feet.

B. Façade Design and Articulation.

1. Facades within 20 feet of a front or street side property line shall include windows, doors, other openings, or glazed areas for at least 40 percent of the building wall area located between 2.5 feet above the level of the sidewalk and the underside of the roof structure for portions of the façade within 75 feet of the street-facing main entry.
2. No street-facing façade may run in a continuous plane for more than 90 feet without an opening.

Figure 7.05-1: Façade Design and Transparency

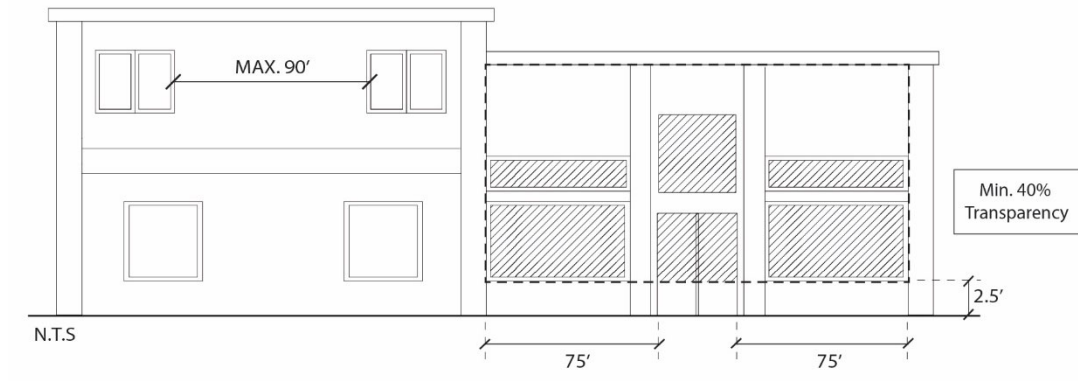

3. All building facades must incorporate window trim and/or window recesses, architectural features, changes in material, changes in texture, or similar design elements that add visual interest to the facade. This includes a varied palette of materials, textures, and colors that emphasize details and changes in plane.

C. Pedestrian and Bicycle Circulation.

1. A system of pedestrian walkways shall connect all primary building entrances on a site to each other, to on-site vehicle and bicycle parking areas, and to any on-site open space areas, pedestrian amenities, and transit stops. Walkways may be located within public utility easement areas provided they are publicly accessible.
2. Walkways between the primary building entrance and sidewalk shall be the shortest practical distance, generally no more than 125 percent of the straight-line distance.
3. Walkways shall be hard-surfaced and paved with materials that are visually distinct from vehicular access areas in terms of composition, texture, and/or color.
4. Where a required walkway crosses a driveway, parking area, or loading area, it must be clearly identifiable through a raised crosswalk, a different paving appearance, material, or similar method.
5. Where a required walkway is parallel and adjacent to a vehicle travel area, it must be raised or separated from the vehicle travel lane by a raised curb at least four inches high, bollards, or other physical barrier.

Figure 7.05-2: On-Site Circulation

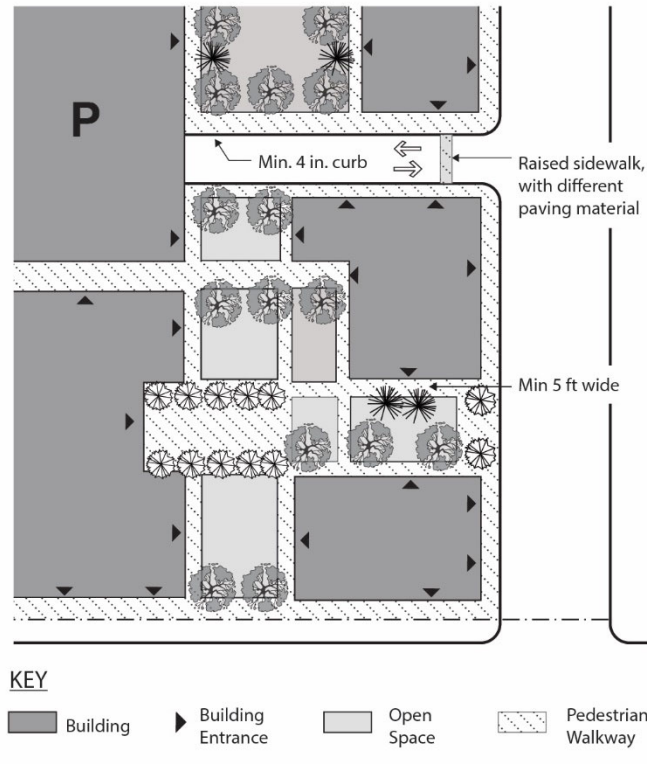

D. Site Design for Large Projects. Projects over 80,000 gross square feet must provide the following:

1. Landscaped areas and usable outdoor common open space [see Subsection XI-10-7.05(D)(2)] equal to a cumulative 10 percent of the site area that:
 - a. Provides gathering space or opportunities for active or passive recreation and benches or other seating.
 - b. Provides amenities that enhance the comfort, aesthetics, or usability of the space, including but not limited to trees and other landscaping, shade structures, drinking fountains, water features, or public art.
 - c. Is separated from on-site parking areas by a minimum of 6 feet.
 - d. May include on-site stormwater treatment areas and landscaped areas.
2. A minimum of 400 square feet of outdoor eating facilities for the use of employees. Outdoor eating areas shall have a minimum dimension of 12 feet and shall include tables, seating and covering to provide protection from sun and weather conditions. Employee eating areas must be contiguous with required on-site public open space or provided in a separate area. This area may be included as part of the open space requirement.
3. Stormwater detention facilities incorporated into the site landscaping. Refer also to Subsection VIII-5-3, Provisions for New and Rehabilitated Landscapes.
4. A lighting, landscaping, and signage design concept for common areas. Refer also to Subsection XI-10-54.17 for general lighting standards and to Subsection XI-10-24 for general signs standards.

E. Landscaping.

1. The following areas shall be landscaped and may count toward the total area of site landscaping required by the zoning district standards.
 - a. Street-Facing Setbacks, as required in Section 10-7.03.B of this Chapter.
 - b. Interior Property Lines Abutting Residential Districts. A six-foot-wide landscape buffer yard planted with a mix of trees and shrubs shall be provided along interior property lines. At least one tree of at least 15-gallon size shall be planted per 20 linear feet or as appropriate based on canopy size at maturity to create a tree canopy over the buffer yard. In addition, at least three shrubs shall be planted per 20 lineal feet. At least 10 percent of the required trees shall be 24-inch box size.
 - c. Building Perimeters. The portions of a building that face a public street or parking areas shall have one or more landscape planters, each a minimum of four feet in depth, installed along a minimum 20 percent of street-facing facades. This 20 percent may include landscape buffers located below windows and other transparent portions of the facade.

Figure 7.05-3: Landscape Planters

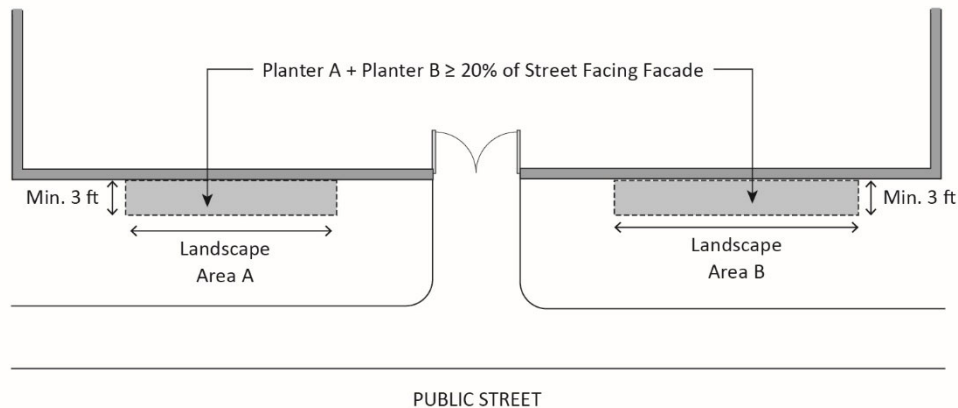

- d. Parking Areas. A minimum of 10 percent of any parking lot area shall be landscaped in the form of planted islands between rows of parking or between parking stalls. For the purpose of calculating required parking lot landscaping, parking lot areas are deemed to include parking and loading spaces as well as aisles, vehicle entry and exit areas, and any adjacent paved areas. Parking lot area does not include enclosed vehicle storage areas.
 - e. Unused Areas. All areas of a project site not intended for a specific use, including areas planned for future phases of a phased development, shall be landscaped or left in a natural state.
2. Landscaping Materials. In addition to the standards of Section VIII-5-3, Provisions for New and Rehabilitated Landscapes, the following landscape standards apply.
 - a. General. Landscaping must consist of a combination of groundcovers, shrubs, vines, and trees. Landscaping may also include incidental features including stepping stones, benches, fountains, sculptures, decorative stones, or other ornamental features, placed within a landscaped setting. Landscaped areas may include paved or graveled surfaces, provided they do not cover more than 10 percent of the area required to be landscaped.
 - b. Plant selection. Plants must be selected to control erosion and provide protection from wind and summer sun.
 - c. Ground Cover Materials. Ground cover shall be of live plant material. Groundcover may include grasses. Non-plant materials including gravel, colored rock, cinder, bark, and similar materials shall not be used to meet the minimum planting area requirements required by this section,

except with approval by the Zoning Administrator. Mulch must be confined to areas underneath shrubs and trees and is not a substitute for ground cover plants.

- d. Turf Allowance. The maximum amount of lawn in required landscape areas shall be 20 percent except for turf areas that comprise an essential component of a project (e.g., golf courses or playing fields), which are exempt from this limit. The installation of turf on slopes greater than 25 percent is prohibited.
- e. Size and Spacing. Plant materials shall be grouped in hydrozones in accordance with their respective water, cultural (soil, climate, sun and light) and maintenance needs. Plants shall be of adequate size and spacing at the time of installation to provide ample vegetation coverage. Minimum requirements include:
 - i. Ground Covers. Ground cover plants other than grasses must be at least the four-inch pot size. Areas planted in ground cover plants other than grass seed or sod must be planted at a rate of one per 24 inches on center or less.
 - ii. Shrubs. Shrubs shall be a minimum size of one gallon. When planted to serve as a hedge or screen, shrubs shall be planted with two to four feet of spacing, depending on the plant species.
 - iii. Trees. Tree canopies shall cover a minimum of 30 percent of the total required landscape area. Of the total number of trees provided on site, at least 20 percent shall be of the same species.
 - (a) A minimum of 15 percent of the trees planted shall be 24 inch-box or greater in size. All other trees shall be a minimum of 15 gallons in size with a one-inch diameter at breast height (dbh).
 - (b) Newly planted trees shall be supported with double stakes or guy wires and tree guards per International Society for Arboriculture and American National Standards Institute standards.
 - (c) Any trees planted along a sidewalk shall be 15 gallon trees no more than 30 feet apart on center.
 - (d) Any tree to be planted along a lot line or adjacent to a structure shall be no closer to said lot line or structure than one-half the diameter of the particular species' drip line at maturity, measured from the center of the tree. Any tree that cannot be planted in the ground shall be planted in a planter box at least twice the width and depth of the root ball plus one additional foot in container diameter for every four feet of mature tree height.

F. Parking and Loading.

1. Parking Location.

- a. Required parking spaces shall be located on the same lot as the use they serve.
- b. Parking areas shall be set back from adjacent buildings and streets as follows:
 - i. From Streets. Where parking is located between a building and street, a landscaped setback at least 10 feet wide must be provided between the parking area and adjacent right-of-way.
 - ii. From On-Site Buildings. Parking areas must be separated from the front and side exterior walls of on-site buildings by walkways at least five feet in width.
- c. On-site parking shall not be located within a required setback.

2. Parking Design.

- a. Access. Driveways shall not exceed 35 feet in width, except that driveways providing large truck access to truck bays shall not exceed 40 feet in width. All driveways must be located a minimum of 50 feet from the boundary of an abutting residential or open space zone.
 - b. Screening. Parking and loading areas shall be screened from view from public streets and properties in abutting residential, mixed-use, or commercial zones, according to the following standards.
 - i. Height. Screening of parking lots from adjacent public streets shall be a minimum of three feet in height. Screening of parking lots along interior lot lines that abut residential or open space districts shall be a minimum of six feet in height.
 - ii. Design. Screening should generally be opaque, but may have some degree of transparency depending on method used (e.g., plant material), and must consist of one or any combination of the methods listed below:
 - (a) Walls. Low-profile walls consisting of brick, stone, stucco, or other quality durable material and including a decorative cap or top finish as well as edge detail at wall ends.
 - (b) Fences. An open fence of wood, wrought iron or similar high-quality, durable material combined with plant materials. This option does not include the use of chain-link or vinyl fencing.
 - (c) Planting. Plant materials consisting of compact evergreen plants. Such plant materials must achieve a minimum height of two feet within 18 months after initial installation.
 - (d) Berms. Berms planted with grass, ground cover, or other low-growing plant materials.
3. Loading Areas. Truck docks, loading areas, and service areas within 100 feet of a public street shall not be visible from the public street. The outermost point of the truck docks, loading, and service areas are not permitted within 50 feet of the boundary of a residential district.

G. Lighting.

1. Fixtures. All exterior lighting fixtures shall be oriented downward, fully shielded, and certified by the International Dark Sky Association to prevent light intrusion into adjacent building buildings and sensitive habitat such as riparian habitat, streams, and wetlands.
 2. Controls. All exterior lighting must be capable of accepting controls that enable dimmers, timers motion sensors, or networking to avoid unnecessary lighting and energy use, especially in areas adjacent to sensitive habitat, such as riparian habitat, streams, and wetlands.
 3. On-Site Lighting.
 - a. Ground-floor building façades and other areas, including parking lots, driveways, pedestrian and bicycle circulation areas, and recesses, shall be illuminated with lighting fixtures that meet the following minimum standards:
 - i. Open parking lots: One foot-candle at ground level.
 - ii. Pedestrian paths/bike paths: One foot-candle at ground level.
 - iii. Covered parking: Five foot-candles at ground level.
 - b. Electrical elements for exterior building lighting such as wires, conduits, and panel boxes shall be concealed from public view or painted to match the background surface color.
-

c. Parking lot lighting shall be designed and installed so that light and glare is not directed onto residential use areas, adjacent public rights-of-way, or sensitive habitat, such as riparian habitat, streams, and wetlands.

4. Prohibited Lighting. The following types of exterior lighting are prohibited:

a. Mercury vapor luminaires;

b. Searchlights;

c. Sky beams;

d. Upward-directed fixtures; and

e. Aerial lasers.

XI-10-7.06 Conformance with Specific Plans

Properties located within Specific Plans shall conform to the underlying Specific Plan in accordance with Section XI-10-11.06, Conformance with Specific Plans, of this Chapter.

(Ord. No. 38.803, § 8, 4/17/12; Ord. No. 38.795, § 26, 4/6/10; Ord. No. 38.789, § 9, 4/21/09)

Section 9 Metro Area Zones and Standards (New Section)

XI-10-9.01 Purpose and Intent

- A. Metro Multi-Family High Density Residential ("R3-Metro") Zoning District. The purpose of the R3-Metro zoning district is to create and enhance high-density residential areas (densities in the range of 30 to 40 dwelling units per acre) characterized by a mix of multi-family unit types and small-scale neighborhood businesses where appropriate. The R3-Metro zone implements the Multi-Family High Density Residential (MFH) land use designation as described in the Metro Specific Plan.
 - B. Metro Multi-Family Very High Density Residential ("R4-Metro") Zoning District. The purpose of the R4-Metro zoning district is to create and enhance very high-density residential areas (densities in the range of 40 to 85 dwelling units per acre) characterized by low- and mid-rise multi-family residential buildings and compatible commercial uses where appropriate. . The "R4" District is intended to provide for higher-density residential "villages" structured around transit stations, streets, creek side open spaces, trails and parks. The R4-Metro zone implements the Multi-Family Very High Density Residential (VHD) land use designation as described in the Metro Specific Plan.
 - C. Metro Urban Residential ("R5-Metro") Zoning District. The purpose of the R5-Metro zoning district is to create and enhance very high-density residential areas (densities in the range of 70-120 dwelling units per acre) characterized by high-rise residential buildings and compatible commercial uses structured around transit stations. The R5-Metro zone implements the Urban Residential (URR) land use designation as described in the Metro Specific Plan.
 - D. Metro High Density Mixed Use ("MXD2-Metro") Zoning District. The purpose of the MXD2-Metro zoning district is to create and enhance areas with a mix of retail, restaurant, entertainment, and commercial service uses on the ground floor and residential or office uses on upper stories, while maintaining a pedestrian-oriented streetscape (mixed-use FARs in the range of 1.0 to 2.5 and residential densities in the range of 40 to 85 dwelling units per acre). It is intended that the required active ground floor uses will ensure neighborhood-oriented retail and services are provided within walking distance of high-density residential development. The MXD2-Metro zone implements the Residential Retail Mixed Use (RRMU) land use designation as described in the Metro Specific Plan.
 - E. Metro Very High Density Mixed Use ("MXD3-Metro") Zoning District. The purpose of the MXD3-Metro zoning district is to create and enhance urban areas characterized by a mix of very-high density housing, retail and employment uses (mixed-use FARs in the range of 2.5 to 5.0 and residential densities in the range of 85 to 250 dwelling units per acre). The MXD3-Metro zone implements the Boulevard Very High Density Mixed Use (BVMU) land use designation as described in the Metro Specific Plan.
 - F. Metro Business Park Research and Development, Limited Residential; (BPRD-R-Metro) Zone. The purpose of the BPRD-R-Metro zoning district is to designate specific areas of the city as important employment centers, especially for jobs in the high-tech industry, with limited, integrated residential development (mixed-use FARs in the range of 1.0 to 5.0). The BPRD-R-Metro zone is intended to accommodate business parks, high-intensity office buildings, advanced manufacturing, other light industrial uses, and limited residential uses. It also enables the integration and growth of research and development, office, and light manufacturing uses on consolidated sites with supportive ancillary uses, typically on the ground floor, such as restaurants, health/fitness centers, limited retail, and child care facilities. The BPRD-R-Metro zone implements the Business Park Research and Development, Limited Residential (BPRD-H) land use designations as described in the Metro Specific Plan.
-

NEW SECTION

G. Metro Business Park Research and Development (BPRD-Metro) Zone. The purpose of the BPRD-Metro zoning district is to designate specific areas of the city as important employment centers, especially for jobs in the high-tech industry (FARs in the range of 1.0 to 2.5, with additional FAR up to 4.0 for properties within 1,000 feet of the Milpitas Transit Center). The BPRD zone is intended to accommodate business parks, high-intensity office buildings, advanced manufacturing, and other light industrial uses, and to enable the integration and growth of research and development, office, and light manufacturing uses on consolidated sites with supportive ancillary uses, typically on the ground floor, such as restaurants, health/fitness centers, limited retail, and child care facilities. The BPRD-Metro zone implements the Business Park Research and Development (BPRD) land use designation as described in the Metro Specific Plan.

XI-10-9.02 Metro Area General Use Regulations

A. Permitted and Conditionally Permitted Uses.

1. Primary uses. The uses identified in Table XI-10-9.02-1, Metro Area Zone Uses, shall be the primary uses allowed to occur on a property. All uses except for those noted shall be conducted within enclosed structures. The primary uses identified in Table XI-10-9.02-1 shall be permitted or conditionally permitted, as indicated:

P	Where the symbol "P" appears, the use shall be permitted.
MCS	Where the symbol "MCS" appears, the use shall be permitted subject to the issuance of a Minor Conditional Use Permit by staff, in accordance with Subsection XI-10-57.04, Conditional Use Permits and Minor Conditional Use Permits, of this Chapter.
C	Where the symbol "C" appears, the use shall be permitted subject to the issuance of a Conditional Use Permit, in accordance with Subsection XI-10-57.04, Conditional Use Permits and Minor Conditional Use Permits, of this chapter.
MC	Where the symbol "MC" appears, the use shall be permitted subject to the issuance of a Minor Conditional Use Permit by the Zoning Administrator, in accordance with Subsection XI-10-57.04, Conditional Use Permits and Minor Conditional Use Permits, of this Chapter.
O	Where the symbol "O" appears, the use is subject to an alternative review process described in a subsequent footnote.

B. Prohibited Uses. The following uses are prohibited:

1. Uses where the symbol "NP" appears within Table XI-10-9.02-1.
2. The following uses are not permitted in any Metro zone:
 - a. Adult Businesses as defined in Subsection 13.04, Adult Businesses, of this Chapter.
 - b. Disinfecting and extermination business.
 - c. Outdoor storage of vehicles.
 - d. Private self-storage facilities.
 - g. Drive through uses (restaurants, pharmacies, etc.).

C. Mixed Use Development. Where a single parcel is proposed for development with two or more of the land uses listed in Table 9.02-1, Metro Area Zone Uses at the same time, the overall project will be subject to the permit with the highest level of review required by the Table for any individual use.

D. Residential uses on Activity Streets and Neighborhood Streets. Residential units are not allowed on the ground floor facing any right-of-way designated as an Activity Street or Neighborhood Street by the Metro Specific Plan Figure 4-6, unless allowed by Subsection 9-05.B. Other residential spaces such as lobbies and

common areas are permitted on the ground floor facing an Activity Street in accordance with Table XI-10-9.02-1.

- E. Other Uses. Any other uses may be considered by the Planning Commission that are similar in accordance with the procedure, prescribed in Subsection 10-54.02, Other Uses Permitted by Commission, of this Chapter.

**Table XI-10-9.02-1
Metro Area Zone Uses**

Uses	R3 Metro	R4 Metro	R5 Metro	MXD2 Metro	MXD3 Metro	BPRD-R Metro	BPRD-Metro	Additional Regulations
Commercial								
Alcoholic Beverage Sales	C ¹	C ¹	C ¹	C	C	C	C ¹	
Business Support Services	NP	NP	NP	MCS	MCS	MCS ¹	MCS ¹	
Convenience store	MC	MC	MC	MCS	MCS	NP	NP	Refer to Subsection XI-10-9.03(A), Special Uses
Grocery Store	NP	NP	NP	C	C	NP	NP	
Grocery Store, Small	P	P	P	P	P	NP	NP	Refer to Subsection XI-10-9.03(A), Special Uses
Pawnshop	NP	NP	NP	C	C	NP	NP	Refer to Subsection XI-10-9.03(C), Special Uses
Personal Services	MCS ²	MCS ²	MCS ²	P ²	P ²	C	C	Refer to Subsection XI-10-9.03(A), Special Uses
Pet Shops	NP	NP	NP	MC	MC	NP	NP	
Repair and Cleaning, Small Items	NP	NP	MCS	P	P	NP	NP	Refer to Subsection XI-10-9.03(A), Special Uses
Retail, Limited	C ³	P	P	P	P	P ¹	P ¹	Refer to Subsection XI-10-9.03(A), Special Uses
Retail Stores, General Merchandise	C ³	P	P	P	P	NP	NP	Refer to Subsection XI-10-9.03(A), Special Uses
Thrift Shop								
<i>Retail only</i>	NP	NP	NP	P	P	NP	NP	Refer to Subsection XI-10-9.03(A), Special Uses
<i>With collections</i>	NP	NP	NP	C	C	NP	NP	
Entertainment and Recreation								
Commercial Athletic Facilities	NP	NP	NP	P	P	MCS ¹	MCS ¹	
Golf Course	NP	NP	NP	NP	NP	NP	NP	
Recreation or Entertainment Facility	NP	NP	NP	C	C	NP	NP	
Health and Veterinarian Uses								
Animal Grooming (no boarding)	NP	NP	NP	MC	MC	NP	NP	
Hospitals or Sanitariums	NP	NP	NP	C	C	NP	NP	Refer to Subsection XI-10-9.03(B), Quasi-Public Uses
Massage Establishment	NP	NP	NP	MC/MC S ⁴	MC/MC S ⁴	C ¹	C ¹	Refer to Title III, Chapter 6 of the Milpitas Municipal Code and to Subsection XI-10-13.16
Medical and Dental Offices and Clinics	NP	NP	NP	P	P	MC	MC	
Medical Support Laboratories	NP	NP	NP	P	P	MC	MC	
Optician and Optometrist Shop	NP	NP	NP	P	P	MC	MC	

NEW SECTION

Uses	R3 Metro	R4 Metro	R5 Metro	MXD2 Metro	MXD3 Metro	BPRD-R Metro	BPRD-Metro	Additional Regulations
Pharmacy or Drug Store	NP	MCS	MCS	P	P	MC	MC	
Veterinary Clinic	NP	NP	NP	P	P	NP	NP	
Industrial Uses								
Advanced Manufacturing	NP	NP	NP	NP	NP	p ⁵	p ⁵	
Agriculture	p ⁶	NP	NP	NP	NP	NP	NP	
Art and Artisan Studio	NP	NP	NP	P	P	MCS	P	
Commercial Laboratory	NP	NP	NP	NP	NP	P	P	
Contractor's Shop	NP	NP	NP	NP	NP	NP	NP	
Custom and Artisan Manufacturing	NP	NP	NP	MCS	MCS	MCS	MCS	
Manufacturing, Assembling, Packaging, and Processing Facility	NP	NP	NP	NP	NP	MCS	MCS	
Parcel hub	NP	NP	NP	NP	NP	NP	MC	
Printing (Newspaper, Blueprint, Publishing)	NP	NP	NP	NP	NP	NP	MC	
Research and Development	NP	NP	NP	NP	NP	p ⁵	p ⁵	
Soils and materials testing laboratories	NP	NP	NP	NP	NP	P	P	
Warehousing and Distribution	NP	NP	NP	NP	NP	NP	NP	
Wholesale Sales	NP	NP	NP	NP	NP	MC	MC	
Lodging Uses								
Bed and Breakfast	P	P	P	P	P	NP	NP	
Boarding Houses	C	C	C	C	C	NP	NP	
Hotels	NP	NP	NP	P	P	P	P	
Motels	NP	NP	NP	NP	NP	NP	NP	
Short-Term Rentals	P	P	P	P	P	NP	NP	Refer to Subsection XI-10-13.17, Short-Term Rentals
Professional Offices Uses								
Offices, Business and Professional	C	C	C	P	P	P	P	
Financial institutions (banks, savings and loans, etc.)	NP	MCS	MCS	P	P	MCS ¹	MCS ¹	
Public, Quasi-Public and Institutional/Assembly Uses								
College and university, private	NP	NP	NP	C	C	P	P	
Conference Center	NP	NP	NP	NP	NP	C	C	
Community Garden	P	P	P	P	P	P	P	
Day Care Center	MC	MC	P	P	P	p ¹	p ¹	Refer to Subsection XI-10-13.06, Large Family Child Care and Child Care Centers
Farmer's Market	MC	MC	MC	MCS	MCS	MCS	MCS	Refer to Subsection XI-10-13.10, Farmers Markets
Instruction, Group	MC	MC	MC	MCS	MCS	NP	NP	
Instruction, Private	MCS	MCS	MCS	P	P	NP	NP	
Park, Playground or Community Center	O ⁷	O ⁷	O ⁷	O ⁷	O ⁷	O ⁷	O ⁷	
Places of Assembly	MC	MC	MC	MCS	MCS	NP	NP	

NEW SECTION

Uses	R3 Metro	R4 Metro	R5 Metro	MXD2 Metro	MXD3 Metro	BPRD-R Metro	BPRD-Metro	Additional Regulations
Public Utilities	NP	NP	NP	NP	NP	NP	NP	
Schools, private (elementary, middle, high)	C	C	C	C	C	C	C	
Theater (indoor)	NP	NP	NP	C	C	NP	NP	
Trade and Vocational School	NP	NP	NP	C	C	C	C	
Transportation Facilities	C	C	C	C	C	NP	NP	
Residential Uses								
Court Dwellings	P	P	P	P	P	NP	NP	
Duplex (two dwellings)	NP	NP	NP	NP	NP	NP	NP	
Group Living Accommodations	C	C	C	C	C	C	NP	
Live/Work	C ⁸	C ⁸	C ⁸	MCS	MCS	MCS	NP	
Multi-Family Dwellings	P	P	P	P	P	P	NP	
Residential Care Facility	P	P	P	P	P	P	NP	
Single-Room Occupancy Residences	MC	MC	MC	MC	MC	NP	NP	Refer to XI-10-13.13, Special Uses, Single Room Occupancy Residences
Transitional and Supportive Housing	P	P	P	P	P	P	NP	Refer to CA Government Code Sec. 65582
Restaurants or Food Service								
Bar or Nightclub	NP	NP	NP	C ⁹	C ⁹	NP	NP	
Brewery/ Eateries	NP	NP	NP	MCS ⁹	MCS ⁹	NP	NP	
Catering Establishment	NP	NP	NP	C	C	NP	NP	
Commissary	NP	NP	NP	NP	MC	NP	NP	
Mobile Food Park	NP	NP	NP	MC	MC	NP	NP	Refer to Subsection XI-10-13.18, Mobile Food Vending
Mobile Food Vending (individual vehicle)	P	P	P	P	P	P	P	Refer to Subsection XI-10-13.18, Mobile Food Vending
Restaurants								
<i>With on-site service of alcohol</i>	C ³	C	C	P/C ¹⁰	P/C ¹⁰	C ¹	C ¹	Refer to Subsection (XI-10-9.03(C)(5))
<i>Without on-site service of alcohol</i>	MCS ³	P	P	P/C ¹⁰	P/C ¹⁰	P ¹	P ¹	Refer to Subsection (XI-10-9.03(C)(5))
<i>With music (indoor/outdoor)</i>	NP	NP	NP	P ⁹	P ⁹	NP	NP	Refer to Subsection (XI-10-9.03(C)(5))
<i>With other live entertainment</i>	NP	NP	NP	C ¹¹	C ¹¹	NP	NP	Refer to Subsection (XI-10-9.03(C)(5))
Vehicle Related Uses								
Auto Broker (wholesale, no vehicles on site)	NP	NP	NP	MCS	MCS	NP	NP	
Auto Rental	NP	NP	NP	MC ¹²	MC ¹²	NP	NP	
Auto Sales	NP	NP	NP	NP	NP	NP	NP	
Mobile Fueling ¹³	P/NP	P/NP	P/NP	P/NP	P/NP	P/NP	P/NP	Refer to the California Fire Code as amended by the City of Milpitas Municipal Code, Title V, Chapter 300.
Service Stations	NP	NP	NP	NP	NP	NP	NP	
Auto Repair Shop	NP	NP	NP	NP	NP	NP	NP	
Accessory and Temporary Uses								

NEW SECTION

Uses	R3 Metro	R4 Metro	R5 Metro	MXD2 Metro	MXD3 Metro	BPRD-R Metro	BPRD-Metro	Additional Regulations
Accessory Dwelling Unit	P	P	P	P	P	P	NP	Refer to Subsection XI-10-13.08, Accessory Dwelling Units
Model home complex	P	P	P	P	P	NP	NP	Refer to Subsection XI-10-13.11(E), Model Home Complexes and Sales Offices
Large family child care home	P	P	P	P	P	P	NP	Refer to Subsection XI-10-13.06, Large Family Child Care and Child Care Centers
Small family child care home	P	P	P	P	P	P	NP	
Temporary seasonal sales	NP	NP	NP	P	P	NP	NP	Refer to Section 13.11, Temporary Uses and Structures

1. Limited to accessory use that supports primary employment-generating uses on the same site. Accessory commercial uses such as restaurants and limited retail shall be located on the ground floor and in an area of the development where they can be directly accessed by the public.
2. When located on the ground floor, retail sales of products related to the Personal Services provided shall be offered at the front of the premises near the pedestrian entrance and shall comprise at least 10 percent of the floor area of the business establishment.
3. No exterior display or advertising and such activities are conducted in spaces which are integral parts of a main building.
4. Allowed with an MCS when an accessory use to any permitted or conditionally permitted medical office, medical clinic, chiropractor practice, acupuncture practice, physical therapist, fitness and athletic facility, health care facility (such as hospitals, nursing homes and sanitariums), and accredited school, college, and university. Massage services, limited to massage of the head, neck, shoulders, hands and feet may be allowed with an MCS when an accessory use to any permitted or conditionally permitted beauty salon, barbershop, and healing art practices. This section shall not exempt any person or business from complying with all the provisions of Title III, Chapter 6.
5. A Conditional Use Permit is required for storage space that exceeds 25,000 square feet, and in no case may storage space exceed 300,000 square feet.
6. The raising of animals or fowl for commercial purposes and the sale of any products at retail on the premises is not allowed.
7. For uses owned and operated by a government agency. The approval process will require that the site be rezoned to POS.
8. Allowed non-residential uses to be specified through the Conditional Use Permit process.
9. Indoor or outdoor music is permitted as an accessory use on the same parcel in conjunction with a restaurant or bar that is a principal permitted use or approved conditional use. See also Subsection XI-10-9.03(E)(6) for additional regulations.
10. Permitted when located on the ground floor facing a public street designated as an Activity Street. Requires a Conditional Use Permit when located elsewhere.
11. "Other live entertainment" Includes but is not limited to dancing, stand-up comedy, theatrical shows, magic shows, and karaoke.
12. Bicycle and auto rental agency, excluding commercial vehicles, trucks, buses, vans, boats and RV rentals, must be fully enclosed within a building.

13. Mobile fueling is permitted when fueling service is ordered by an individual vehicle owner and the amount of fuel dispensed as part of any individual order does not exceed 50 gallons. Mobile fueling for fleet vehicles is not permitted.

XI-10-9.03 Metro Area Special Use Regulations

- A. Personal services, convenience stores, grocery stores, retail, repair and cleaning services, private and group instruction, and financial institutions within R3-Metro, R4-Metro and R5-Metro zones may be permitted provided they are:

1. Less than or equal to 10,000 square feet in gross floor area;
2. Not open past 10:00 p.m.;
3. Conducted wholly within a building, except for approved outdoor seating areas;
4. Not specifically noted in Table XI-10-9.02-1, Metro Zone Uses, of this Chapter, requiring Conditional Use Permit approval; and
5. Not listed as a prohibited use in Section XI-10-9.02(B), Prohibited Uses, of this Chapter.

If items (1) through (3), above, are not met, then approval of a Conditional Use Permit is required in accordance with Section 10-57.04 of this Chapter.

- B. Quasi-Public Uses. The following uses may be permitted within the MXD2-Metro and MXD3-Metro zones provided their location is first approved by the Planning staff, the Zoning Administrator, or the Planning Commission (as applicable), in accordance with Subsection 57.04, Conditional Use Permits and Minor Conditional Use Permits, of this Chapter, and they are not located within 1,000 feet of the parcel boundary of another quasi-public use listed below. This distance shall be measured from the property line of the parcel where such use is located.

1. Places of meeting or assembly, such as auditoriums, banquet halls, and fraternal or union halls. Churches and religious institutions are exempt from this spatial requirement.
2. Private elementary, middle or high schools.
3. Vocational schools, if not found objectionable due to noise, odor, vibration or other similar health, safety and welfare basis.

- C. Performance Standards for Certain Uses. For uses requiring approval of a Minor Conditional Use Permit by staff, in accordance with Section 10-57.04, Conditional Use Permits and Minor Conditional Use Permits, of this Chapter, the following performance standards below shall be met.

1. The following uses may not be located within 1,000 feet of another same use listed below. This distance shall be measured from the property line of the parcel where such use is located.
 - a. Vehicle Related Uses.
 - b. Transportation facilities without outdoor storage of vehicles.
 - c. Pawnshops.
2. Auto Brokers. Auto Brokers are subject to the following standards:
 - a. Local Sales and Use Tax. In order to assist the City of Milpitas in its efforts to receive direct distribution of the local tax on materials associated with the project, the California Sales and Use Tax (the "Local Tax") shall be allocated to the project site, to the extent reasonably possible. Evidence of tax allocation or cause as to why such allocation cannot be made shall be submitted at the time of business license submittal.
 3. Art and Artisans Studios shall comply with the following standards:
 - a. All operations shall be conducted completely within an enclosed building.

NEW SECTION

- b. There shall be no dust, fume, or odor either emitted from the premise.
 - c. The operations shall not create excessive vibrations.
 - d. The operations shall be consistent with the City's noise standards.
4. Outdoor Music in the MXD2-Metro and MXD3-Metro zones:
1. Outdoor music as an accessory use in conjunction with a restaurant or bar shall be permitted for the entertainment and enjoyment of customers at the restaurant or bar during regular operating hours. Outdoor music as an accessory use shall be limited to the hours of 9:00 a.m. to 11:00 p.m.
 2. Recorded background music may be permitted outdoors on public sidewalks and other public areas subject to the standards of this Chapter and Title V - Public Health, Safety and Welfare, Chapter 213 - Noise Abatement.
 3. Noise levels for outdoor music, when permitted as an accessory use to a restaurant or bar, shall not exceed a maximum range of 70 to 90 decibels (dB). See also Title V - Public Health, Safety and Welfare, Subsections V-213-2 and V-213-3, for additional regulations.
 4. Larger outdoor music events, both live and recorded music, which are intended for the entertainment and enjoyment of the general public shall not be considered accessory uses and shall require a Special Event Permit pursuant to Section 15, Special Events and Activities, of this Chapter.
 5. Minor outdoor music events, both live and recorded music, which are hosted onsite by a business with nine or fewer employees shall be exempt from applicable permit and fee requirements.
5. Restaurant Performance Standards. Restaurants shall comply with the following performance standards:
- a. Outdoor seating is allowed if it has been approved as part of the facility's Minor Site Development Permit or Site Development Permit and is operated in conformance with any conditions of that approval.
 - b. Outdoor dining shall comply with the standards of Section 10-13.19 – Outdoor Dining.
 - c. The restaurant shall comply with the City Council's Guidelines for Recycling Enclosures (Resolution No. 6296).
 - d. The restaurant shall incorporate measures to reduce odors to acceptable levels, including, but not limited to, installation of a scrubber, carbon filter or similar equipment, on the roof vent to control odors.
 - e. All the facility's floor drains, trash compactors and indoor mat and equipment washing areas shall be drained to the sanitary sewer.
 - f. Where applicable, the restaurant shall maintain an active account with a tallow hauling company.
 - g. The restaurant shall prepare and implement a program assigning restaurant staff responsibility for complying with the following guidelines which shall be adhered to while the restaurant is in operation:
 - i. Wash all containers and equipment in the kitchen areas so that wash water may drain into the sanitary sewer.
 - ii. Keep garbage dumpsters clean inside and out; replace very dirty dumpsters with new, clean ones.
 - iii. Double bag waste to prevent leaking.

- iv. Place, do not drop or throw, waste-filled bags, to prevent leaking.
- v. Keep the ground under and around the garbage dumpsters swept.
- vi. Sprinkle the ground lightly after sweeping with a mixture of water and a little bleach.
- vii. Hold training sessions to instruct employees on the proper procedures in the handling and disposal of food items; the general maintenance and use of the compactor and any other procedures that would assist the business in complying with all State and local health and sanitation standards. A record of such training must be kept to prove compliance with this requirement.
- viii. Post signs (in English and multi-lingual) inside the premises for all employees identifying procedures for food delivery and garbage disposal.
- ix. All garbage bins shall be stored in the garbage enclosure except for the 12 hours immediately before and after garbage collection.

XI-10-9.04 Metro Area General Development Standards

- A. Standards within the Metro Specific Plan area. For all Metro Area properties, refer to the Metro Specific Plan for development standards. When a standard is not listed within the Metro Specific Plan, the standards listed within the zoning ordinance shall govern.
- B. General Standards. The following requirements shall be observed.

**Table XI-10-9.04-1
Metro Zones Development Standards**

Standard	R3 Metro	R4 Metro	R5 Metro	MXD2 Metro	MXD3 Metro	BPRD-R Metro	BPRD- Metro
<i>Min. Lot Area</i>	8,000 sq ft	none	none	none	none	none	none
<i>Residential Density¹</i>	30-40 units/ac	40-85 units/ac	70-120 du/ac	40-85 units/ac	85-250 units/ac	No min. or max.	N/A
<i>FAR</i>	n/a	n/a	n/a	Mixed Use: 1.0-2.5 FAR	Mixed Use: 2.5-5.0 FAR	Mixed-use: 1.0-5.0 FAR; min. 1.0 FAR non-residential uses	Min. 1.0; Max. 2.5-4.0 ²
<i>Active Use</i>	none	none	none	Ground floor retail and active uses required on 80% of frontages on any one blockface along any Activity Street as identified on the Metro Specific Plan Figure 4-6: Circulation Network.			none
<i>Front Setback</i>	20 ft min.	8 ft min., 20 ft max. from back of sidewalk	12 ft min., 20 ft max. from back of sidewalk	Min. 0 ft, Max. 20 ft	Min. 12 ft, Max. 20 ft	Min. 10 ft, Max. -20 ft	Min. 0 ft.
<i>Interior Side Setback</i>	<i>1 story:</i> Each side 5 ft min, total of 12 ft both sides <i>2-2.5 story:</i> Each side 10 ft min, total 25 ft both sides <i>3-3.5 story:</i>	10 ft min.	15 ft; 20 feet for buildings over 3 stories abutting residential uses	0 ft; 10 ft when abutting residential use and for portions of buildings over 60 ft or 4 stories tall	10 ft; 15 ft when abutting residential; 20 ft for portions of buildings over 60 ft or 4 stories tall	10 ft min.	10 ft min.

NEW SECTION

Standard	R3 Metro	R4 Metro	R5 Metro	MXD2 Metro	MXD3 Metro	BPRD-R Metro	BPRD- Metro
	Each side 12 ft min, total 30 ft both sides						
<i>Street Side Setback</i>	10 ft	8 ft min., 15 ft max. from back of sidewalk	12 ft min., 20 ft max. from back of sidewalk	0 ft	12-20 ft	10-15 ft	0 ft min.
<i>Rear Setback</i>	1 story: 30 ft 2-2.5 story: 35 ft 3-3.5 story: 40 ft	10 ft min.	15 ft; 20 feet for buildings over 3 stories abutting residential uses	10 ft; 15 ft when abutting an R Zone; 20 ft for portions of building over 60 ft or 4 stories tall	15 ft; 20 ft when abutting an R zone; 30 ft for portions of building over 60 ft or 4 stories tall	10 ft min.	10 ft min.
<i>Creek/Drainage Channel Setback</i>	25 ft from top of bank or from any maintenance road or required setback, whichever is greater.						
<i>Max. Primary Building Height</i>	75 ft	35 ft min., 75 ft max.	75 ft and 6 stories	85 ft ³	275 ft ⁴	275 ft or 18 stories	8 stories
<i>Accessory Building Height</i>	Max. 25 ft or 2.5 stories						
<i>On-Site Open Space</i>	Residential and mixed-use projects: Min. 100 sq ft per residential unit, may be private or common Non-residential projects: Min. 10% of site area						Min. 15% of site area
<i>Private Open Space Dimensions</i>	Min. 4 ft x 6 ft						n/a
<i>Common Open Space</i>	Residential and mixed-use projects: Min. 30% of the total open space provided on-site; Min. dimension 10 ft						Min. dimension 10 ft
<i>Publicly Accessible Open Space</i>	Mixed-use projects: Min. 5% of the total open space provided on-site ⁵ Non-residential projects: Min. 25 contiguous sq ft per 10,000 sq ft non-residential floor area.						Min. 25 contiguous sq ft per 10,000 sq ft non-residential floor area excluding retail, restaurant, or service areas

1. When determining the density of non-traditional housing configurations such as group living accommodations and single-room occupancy residences, three bedrooms may be counted as the equivalent of one unit.
2. Maximum allowed FAR is based on the following sliding scale:
 - 2.5 for properties farther than 3,000 ft from the Milpitas Transit Center;
 - 3.0 for properties within 3,000 ft from the Milpitas Transit Center;
 - 3.5 for properties within 2,000 ft from the Milpitas Transit Center;
 - 4.0 for properties within 1,000 ft from the Milpitas Transit Center.

3. Within 60 feet of adjacent existing residentially zoned parcels, building height shall be stepped down to a maximum of 10 feet higher than the maximum allowed height of the adjacent parcel.
4. A maximum 50% of base footprint may reach 85 feet in height and a maximum 25% of base footprint may reach 275 feet in height.
5. Required publicly accessible open space may include one or more of the following types of public open spaces: park, plaza, garden, public sitting area.

XI-10-9.05 Metro Area Special Development Standards

- A. R3-Metro Zone.
 1. On-Site Utilities Requirements.
 - a. Where the allowable dwelling units exceed six for a single parcel or the total area to be subdivided exceeds three acres, all on-site utilities are to be placed underground.
 - b. Television antennas are to be centralized for structures of four or more units.
 2. Trash and Storage Areas and Areas for Collecting and Loading Recyclable Materials.
 - a. There shall be provided areas for collecting and loading recyclable materials in accordance with the requirements of Section 10-54.12 of this Chapter.
 - b. All outdoor storage and trash areas shall be within a completely enclosed building or behind a solid wall or tight board fence a minimum of six feet in height.
- B. 2023-2031 Housing Element Rezone Sites. Rezone sites are listed in the City of Milpitas 2023-2031 Housing Element, Appendix E, Table E-14. Rezone sites within the Metro Specific Plan are sites R-11 to R-29, which all provide lower-income housing capacity (see City of Milpitas 2023-2031 Housing Element Table E-14 and Figures E-4 and E-5). On these rezone sites (sites R-11 to R-29), the following shall apply:
 1. Owner-occupied and rental multi-family housing uses shall be allowed by right (i.e., without any discretionary review) when at least 20 percent of the units will be affordable to lower income households.
 2. 100 percent residential use is allowed.
 3. A minimum of 50 percent of the floor area in mixed-use projects must be occupied by residential use(s).
- C. BPRD-Metro and BPRD-R-Metro zones.
 1. Fences, Hedges and Walls.
 - a. All planting, fencing and walls for new development, including but not restricted to fences and walls along rear and interior side property lines shall be approved by the review authority. Modifications regarding landscaping, fencing and walls at existing developed sites shall be subject to the provisions of Subsection 54.10, Fences and Walls, of this Chapter.
 - b. Temporary buffers must be installed when residential uses are developed adjacent to existing industrial uses. The buffers, which may be fences, walls, or vegetation, are subject to the provisions of Subsection 54.10, Fences and Walls, of this Chapter and must be reviewed and approved by the City Planning Department. The temporary buffers may be removed if and when an adjacent site is redeveloped as a non-industrial use.
 2. Utilities. All wires, pipes, cables and utility connections shall be placed in underground or subsurface conduits. All above ground transformers and vaults for new development shall be adequately screened

NEW SECTION

- to the approval of the review authority. Modifications regarding subsurface conduits or above ground transformers and vaults at existing developed sites shall be subject to the provisions of Subsection 54.16, Trash Enclosures, Equipment and their Screening, of this Chapter.
3. Loading dock/doors. A maximum of two loading docks are allowed for any single project and must be located out of view from the primary abutting right-of-way.
 4. Areas for Collecting and Loading Recyclable Materials. There shall be provided areas for collecting and loading recyclable materials in accordance with the requirements of Subsection 54.12, Areas for collecting and loading recyclable materials, of this Chapter.
 4. Legal Nonconforming projects. Existing developments lawful at the time of installation or improvements which have been approved and a building permit issued prior to June 17, 1982, and installed in conformance with said approval and permit are considered legal nonconforming projects.
 5. Uses in the BPRD-Metro and BPRD-R-Metro zones shall:
 - a. Emit no obnoxious, toxic or corrosive fumes or gases.
 - b. Emit no odors perceptible at the property line.
 - c. Emit no smoke.
 - d. Discharge into the air no dust or other particulate matter created by any industrial operations or emanating from any products stored prior or subsequent to processing.
 - e. Produce no heat or glare perceptible beyond the lot boundaries.
 - f. Utilize all lighting in a manner which produces no glare on public streets or on any other parcel.
 - g. Produce no physical vibrations perceptible at or beyond the lot boundaries.
 - h. Produce no electromagnetic radiation or radioactive emission injurious to human beings, animals or vegetation, except under controlled operations being conducted observing standards or methods or operation established by the Nuclear Regulatory Commission. Electromagnetic radiation or radioactive emissions shall not be of an intensity that interferes with the use of any other property.
 - i. Do not engage in the production or storage of any material designed for use as an explosive, or in the use of such material in production.
 - j. Indicate that all industrial uses shall use only gas, electricity, or preheated oil as a fuel; provided, however, that oil-burning equipment may be installed for stand-by emergency use only.
- D. Equipment and Screening in all Metro Zones.
1. Trash enclosures and utility equipment (mechanical, electrical, and plumbing) may not be located within the front setback. Public utilities are excluded from this requirement.
 2. All exterior equipment and enclosures shall be screened or incorporated into the design of buildings so as not to be visible from public rights of way or public spaces.
 3. See also Subsection 54.16 – Trash Enclosures, Equipment and their Screening for standards related to equipment and screening.

XI-10-9.06 Metro Area Special Design Standards

- A. All residential and residential mixed-use development must comply with the Milpitas Residential and Mixed-Use Objective Design Standards in addition to the standards of this subsection 10-9-.06. Where standards of this subsection conflict with those of the Objective Design Standards, this section supersedes.

- B. All non-residential development in the BPRD-R-Metro, BPRD- Metro zones must comply with the standards of Section 10-7.05, Special Design Standards for the BPRD Zone in addition to the standards of this Subsection 10-9-.06. Where standards of this subsection conflict with those of Section 10-7.05, the more restrictive standard applies.
- C. Block Length.
 - 1. Blocks may not exceed 700 feet in length.
 - 2. Blocks more than 500 feet in length must incorporate a mid-block pedestrian and bicycle through connection.
- D. Building Articulation.
 - 1. In the R3-Metro, R4-Metro and R5-Metro zones, the third floor and above must be stepped-back from the ground-floor street-facing building façade by a minimum of 8 feet.
 - 2. In the MXD2-Metro and MXD3-Metro zones, the fourth floor and above must be stepped-back from the ground-floor street-facing building façade by a minimum of 8 feet.
 - 3. In the BPRD-R zone, the fifth floor and above must be stepped-back from the ground-floor street-facing building façade by a minimum of 8 feet.

Figure 9.06-1: Building Step-Back

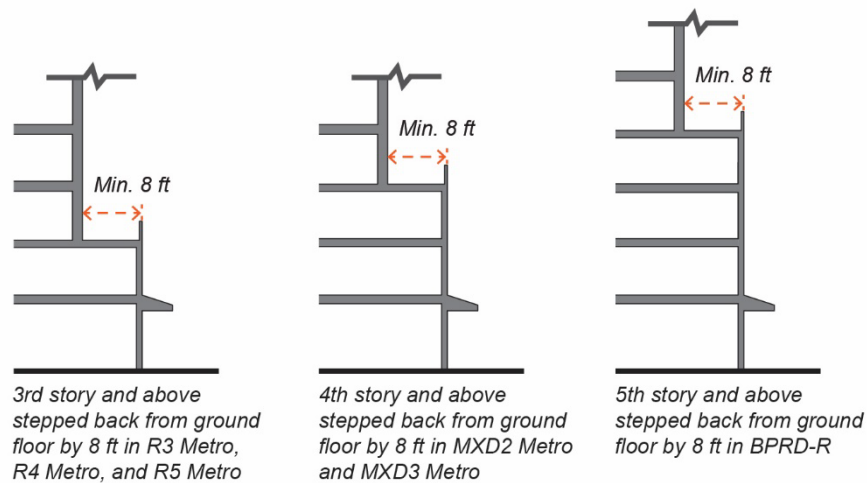

- 4. Non-residential building façades over 80 feet in length shall break up long street walls through at least two of the following features: recesses a minimum six feet in depth; awnings; colonnades; projections a minimum four feet in depth; step-backs a minimum six feet in depth; window reveals; cornice treatment; and changes in color and material.
 - 5. Non-residential building height must vary such that the building has at least one change in height of at least one story. This may be achieved through changes in pitch, plane, orientation, a change in the number of stories, differentiated forms, projections and recesses and/or special architectural features such as towers.
- E. Ground Floor Commercial Design Standards. On retail mixed use streets, and in any other areas with ground floor retail, restaurant, and commercial service uses, the following standards apply:

NEW SECTION

1. Ground floor spaces shall be a minimum of 60 feet in depth for a minimum of 50 percent of the space, and a minimum of 40 feet in depth for any remaining space.
 2. Floor to Ceiling Height.
 - a. Retail: Minimum 18 feet floor-to-floor and a minimum 14 feet clear.
 - b. Office: Minimum 14 feet.
 3. Building Entrances. There shall be at least one entrance per 100 feet of building frontage and the main entrance may not face a parking lot.
 4. Wall Plane Articulation. Windows, doors, columns, and other features shall be recessed or project forward, such that there is a six-inch difference between wall and window surfaces and a total of at least eighteen inches from the window to the outermost plane of a wall or column.
 5. Floor Elevation. Ground floor elevation shall be no more than two feet above or below the sidewalk level.
- F. Building Materials.
1. Ground Floor Materials. All ground floor exterior materials shall be durable, quality materials, such as glass, concrete, precast concrete, aluminum and high quality metal panels, composite panels, stone, and stucco.
 2. Non-residential Building Materials. Primary building materials in all non-residential construction shall store carbon (e.g., wood, calcium carbonate-based cementitious substances, synthetic limestone).
 3. Glass Materials. Glass types shall be clear glass, frit glass, sandblasted glass, spandrel glass, or channel glass. Glazing should provide a high degree of light transmittance and be non-reflective.
 4. Roofing Materials. Roof design and materials shall include vegetated roofs, high-albedo built-up roofs, high albedo single-ply roofing, metal, terracotta tile, concrete tile, composite concrete tile, skylights, solar collectors, and photovoltaics.
 4. Window Materials. Vinyl-frame windows and doors are prohibited. Wood-framed windows must have metal or fiberglass cladding on the exterior. Metal-frame windows must be thermally broken.
- G. Unit Design.
1. A minimum of 10 percent of units in any single residential project shall be designed to be accessible to all users using the principles of Universal Design.
 2. Public plazas shall be constructed with ADA-compliant ramps and tactile warning strips at the crosswalks. Equipment and facilities such as tables, trash cans, restrooms, and drinking fountains should allow for universal access, including people of all ages and ability levels.
- H. Landscaping and Site Design.
1. All development projects shall include on-site vegetated stormwater treatment and landscaping and shade trees at a rate of one tree per 5,000 square feet of the residential building footprint and one tree for every 10,000 square feet of developed lot area for non-residential or mixed-use development.
 2. Where a creek runs under a site, the applicant must coordinate with the City Planning Department to daylight the waterway as part of the site design.
 3. All applicants shall also reference the Santa Clara Valley Urban Runoff Pollution Prevention Program C.3 Stormwater Handbook.
- I. Parks and Publicly Accessible Open Spaces.

1. All development projects shall dedicate land for parks if a park is shown on the subject property on Figure 2-16: Existing and Proposed Parks, of the Metro Specific Plan.
 2. Privately-owned public open space must remain accessible and open to the public during business hours. Private single-access gates are prohibited.
 2. The Recreational Value System as described in the Metro Specific Plan Section 2.8, Parks and Public Spaces Framework, shall be used to ensure park improvements provide a diversity of active, contemplative, and social gathering experiences.
 3. Parks must be bordered by a public right-of-way such as a street, trail or railroad, on at least three sides, and must be clearly visible and accessible from all abutting rights-of-way.
 4. Small neighborhood-serving parks less than one-quarter acre must be located a minimum 500 feet from Montague Expressway, the Great Mall Parkway, or any rail line.
 5. Seating shall be provided in all publicly-accessible open spaces. Seating may include both moveable and fixed seating as well as seat walls, steps, boulders, and other multi-use objects and must be placed along pathways and within or near gathering spaces.
- J. Common and Private Open Spaces.
1. Private open spaces may take the form of balconies, patios, gardens, porches, decks, or roof decks.
 2. Usable open space surfaces may be any combination of lawn, garden, flagstone, wood planking, concrete, or other dust-free surfacing, and may not exceed 10 percent slope.
 2. Universal access shall be provided to all rooftop amenities. An accessible path to a publicly accessible restroom on an adjacent floor or at the rooftop level shall be provided for any common outdoor open space on the rooftop.
 3. A minimum of 10 percent of common rooftop open spaces shall be landscaped using green roofs or planters.
- K. Parking Design. Where parking is required or proposed, it must comply with the following:
1. Parking location. Off-street parking must be located in:
 - a. Ground-floor “tuck-under” individually secured garages;
 - b. Shared garages (podium or underground); or
 - c. Above-ground structures “wrapped” with habitable uses.
 2. Tandem Parking. Tandem parking may be provided in accordance with the following:
 - a. No more than two vehicles may be placed one behind the other.
 - b. Both spaces shall be assigned to a single dwelling unit or to employees of the same non-residential establishment.
 - c. Each tandem parking bay must be a minimum 40 feet in length by 10 feet in width.
 3. Ground-level visibility.
 - a. Individually secured garages. Individually secured garages shall be accessed from a shared rear or side drive aisle where such abuts the property. Where individual garages are accessed from the right-of-way, garages shall occupy no more than 50 percent of the frontage of each unit.
-

Figure 9.06-2: Individual Garages

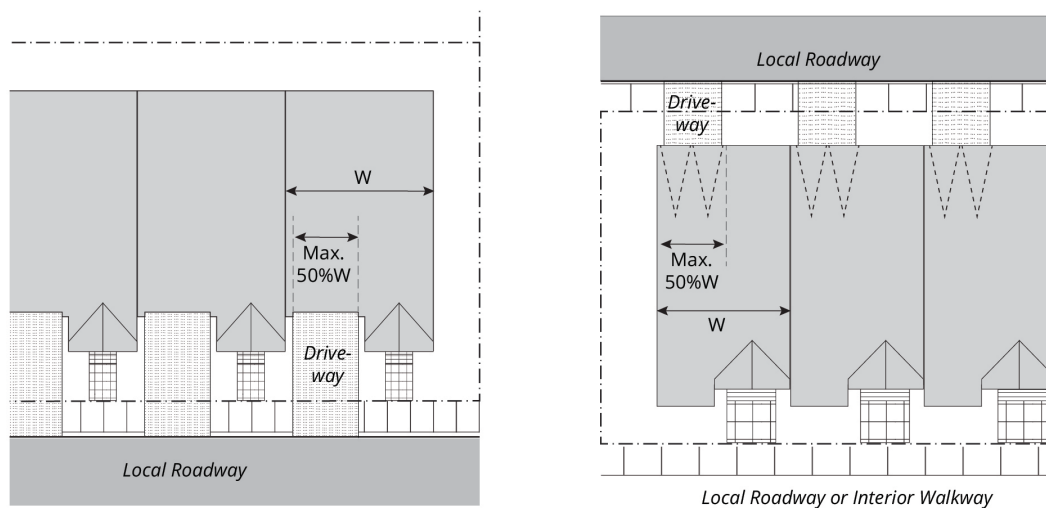

- b. Structured parking. Structured parking may not be located along the ground-level building frontage unless the parking is:
 - i. Recessed a minimum of four feet from the rest of the building façade and screened with a living wall or textured or decorative screening; or
 - ii. Designed such that the parking area is located in a basement, where the vertical distance from grade to the finished floor directly above the parking area is a maximum of 42 inches.

Figure 9.06-3: Structured Parking Ground Level

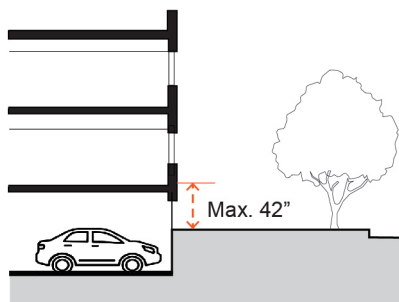

- 4. Upper-level visibility. All upper-level street-facing structured parking must be screened from view from the right-of-way by at least one of the following features:
 - a. Regular openings designed to resemble windows of habitable spaces that do not reflect the sloping floor lines of interior parking ramps on the facade;
 - b. A trellis or living wall; or
 - c. Textured or decorative screening.
- 5. Vehicle access. Parking must comply with the following standards:
 - a. A maximum of one driveway to shared parking is permitted on street frontages up to 120 feet in length; a maximum of two shared driveways are permitted on street frontages exceeding 120 feet in length.

- b. Controlled entrances to shared parking facilities (i.e., gates, doors, etc.) shall be located a minimum of 10 feet from the back of sidewalk.
- c. Vehicular entrances to parking areas shall be a minimum of 80 horizontal feet from vehicular entrances to parking areas on adjacent properties.
- d. Mechanical parking lifts are allowed in all structured parking configurations.

Figure 9.06-4: Parking Access

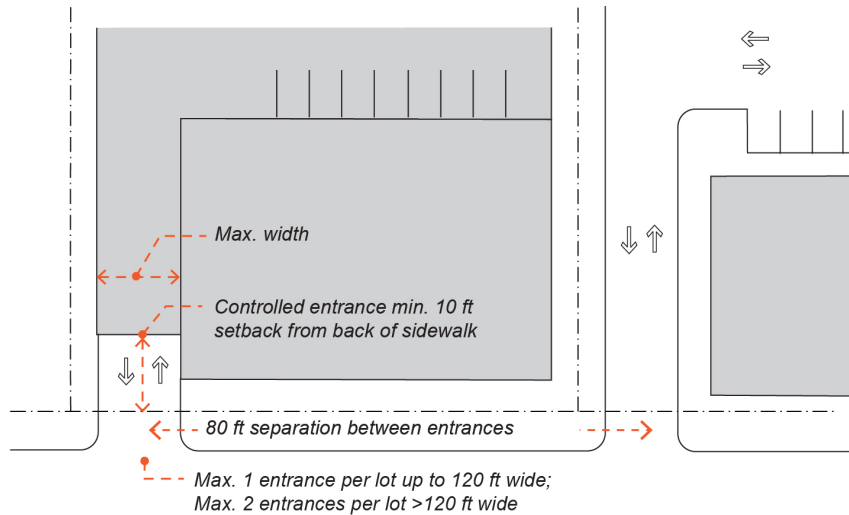

- 6. Parking separation. Parking for residential units shall be physically separated from parking for non-residential uses through a controlled fence, gate, or other barrier.
- L. Pedestrian and Bicycle Circulation.
- 1. A system of pedestrian walkways shall connect all primary buildings entrances on a site to each other, to on-site automobile and bicycle parking areas, and to any on-site open space areas, pedestrian amenities, and transit stops.
 - 2. Walkways shall be the shortest practical distance between the primary building entrance and sidewalk, generally no more than 125 percent of the straight-line distance.
 - 3. Walkways must link the entrances with on-site open spaces, on-site services, and other internal facilities.
 - 4. Walkways shall be a minimum of five feet wide, hard-surfaced, and paved with permeable materials.
 - 5. Where a required walkway crosses a driveway, parking area, or loading area, it must be clearly identifiable through a raised crosswalk, a different paving material, or similar method.
 - 6. Where a required walkway is parallel and adjacent to a vehicle travel area, it must be raised or separated from the vehicle travel lane by a raised curb at least four inches high, bollards, or other physical barrier.
- M. Utilities.
- 1. Utilities shall be placed in underground or subsurface conduits.
 - 2. All mechanical equipment, ground transformers and meters shall be located and screened to minimize visual impacts.

NEW SECTION

3. Rooftop mechanical equipment shall be concealed from street level views through roof designs that area architecturally integrated with the building, such as equipment wells and parapets.
4. Public utility distribution meters, vaults and similar installations shall be consolidated in a single area whenever possible and located away from highly visible areas such as street corners and public open spaces.
5. Backflow preventors shall be located within landscaped setback areas and painted black or dark green to minimize visual impact. Where no landscaped setback areas exist the backflow preventors shall be incorporated into the front of the building to minimize visual obtrusiveness.
6. Refuse and recycling containers shall not be visible from a public or private street. Such containers shall be stored either within the parking facility of the building or within a vehicular accessway with screening designed to meet the requirements of this section.
7. Trash enclosure walls shall incorporate building materials and colors that match the architecture of the building and be well landscaped.
8. All telecommunications antennas shall be building facade or roof mounted and screened appropriately.
9. On Main Street only telecommunication facilities that are disguised to appear as a part of the building architecture (i.e., "stealth" antennas) may be used.

XI-10-9.07 Affordable Housing

Affordable housing units should be provided in all new housing projects consistent with Title XII, Chapter 1 (Affordable Housing Ordinance).

XI-10-9.08 Exceptions to Standards

1. Exceptions to all but the use, floor area ratio, density, and park land requirement regulations of this Section may be approved by the Planning Commission through approval of a Conditional Use Permit in accordance with the requirements of Section 57, Conditional Uses Permitted by Commission, of this Chapter.
2. In addition to the required findings under Chapter 57, the Planning Commission must be able to make the following two additional findings for such exceptions:
 - a. The exceptions meet the design intent identified within the Zoning District and/or Specific Plan and do not detract from the overall architectural, landscaping and site planning integrity of the proposed development.
 - b. The exceptions allow for a public benefit not otherwise obtainable through the strict application of the specified standard.
 - c. The project design in its totality does not adversely impact adjoining properties to a greater degree than a project that complies with all development standards. Impacts to be considered include: access to sunlight, views, shadows on parks and open space, privacy, and noise.

Section 53 Off-Street Parking Regulations¹

XI-10-53.01 Purpose and Intent

The following off-street parking requirements are regulations which are established in order to achieve, among others, the following purposes:

1. To establish minimum requirements for the off-street parking of motor vehicles in accordance with the use established on the property;
2. To relieve congestion on streets, and to provide more fully for movement of traffic, maneuvering of emergency vehicles or street maintenance equipment;
3. To protect neighborhoods from vehicular traffic congestion generated by the adjacent nonresidential uses of land; and
4. To promote the general welfare and convenience and prosperity of residential, commercial and manufacturing developments which depend upon the availability of off-street parking facilities.

(Ord. No. 38.785, § 7, 4-7-09)

XI-10-53.03 Applicability

Off-street parking spaces shall be provided in accordance with the schedule in Table 53.09-~~13~~, Number of Parking Spaces Required, of this Section and improved as per Section 54.03 as a condition precedent to the occupancy of an institutional, commercial or manufacturing use and in conformance with other provisions of this Chapter:

1. Whenever a building is constructed; or
2. Whenever an existing building or use is altered, resulting in an increase in floor area, seating capacity or other units of measurement specified herein for required parking or loading facilities; or
3. Whenever the use of an existing building is changed to a use requiring fifty percent (50%) or more off-street parking spaces, as determined by the provisions of Table 53.09-~~13~~, Number of Parking Spaces Required, of this Section.

(Ord. No. 38.785, § 7, 4-7-09)

¹Editor's note(s)—Ord. No. 38.785, § 7, adopted April 7, 2009, amended the Code by repealing former Section 53, §§ XI-10-53.01—XI-10-53.23, and adding a new Section 53. Former Section 53 pertained to similar subject matter, and derived from Ord. 38, adopted March 15, 1955; Ord. 38.384, adopted October 26, 1976; Ord. 38.530, adopted July 21, 1981; Ord. 38.546, adopted May, 1982; Ord. 38.665, adopted October 29, 1991; Ord. 38.675, October 20, 1992; Ord. 38.702, adopted August 15, 1995; Ord. 38.708, adopted August 6, 1996; Ord. 38.716, adopted September 15, 1998; Ord. 38.759, adopted April 2, 2002; Ord. 38.760, adopted September 17, 2002; Ord. 38.761, adopted May 20, 2003; Ord. 38.763, adopted April 20, 2004; and Ord. 38.776, adopted March 18, 2008.

XI-10-53.05 Maintenance of Off-Street Parking

- A. Continuation of Off-Street Parking. All off-street parking spaces shall continue unobstructed in operation, shall not be used for vehicle repair work of any kind unless within a building, and shall not be reduced below the required size as long as the primary use remains, unless an equivalent number of spaces is provided for said use in another approved location. This does not apply to those parking spaces which are established on a voluntary basis which are in excess of the requirements of this Chapter.
- B. Temporary Sales, Storage and Advertising. The sale or storage of merchandise in permissive parking areas may be allowed by the Zoning Administrator through the approval of a Minor Site Development Permit and subject to such reasonable conditions as may be deemed necessary by the Planning Commission to ensure adequate parking, access and circulation.

In no event shall any off-street parking space (permissive or otherwise) or lot be used for the stopping, standing or parking of any vehicle(s) for either the purpose of selling such vehicle (excluding an approved car sales lot), or advertising any other property, services or products on said vehicle.
- C. Maintenance. All parking areas shall be kept clean and free of dirt, oil, mud or trash; pavement and striping shall be maintained in a continuous state of good repair.
- D. Acknowledgment of Parking Spaces in Residential Projects. For new residential tract, multi-family or condominium projects, the amount and type of parking available to each dwelling unit shall be clearly stated within the CC&Rs in large font and bold lettering to the approval of the City Attorney or designee.

(Ord. No. 38.834 , § 8, 8/20/19; Ord. No. 38.785, § 7, 4-7-09)

XI-10-53.07 Types of Parking Allowed

- A. Standard Parking Spaces. The number of parking spaces required for various land uses shall be as required in Table 53.09-~~43~~3, Number of Parking Spaces Required. Parking spaces shall be designed as required in Subsection 53.13, Design Standards for Off-Street Parking Facilities, of this Chapter.
- B. Compact Parking Spaces. For parking areas and garages containing ten (10) or more stalls serving the following uses in Subsection 53.07(B)(1), up to forty percent (40%) of the required and non-required stalls may be designed as compact stalls to accommodate compact cars.
 - 1. Applicable uses.
 - a. Commercial uses (CO, C1, C2, HS, TC zones).
 - i. Standards. Compact stalls shall be dispersed throughout the parking lot.
 - b. Industrial uses.
 - i. Research and Development (R and D) facilities.
 - ii. Manufacturing facilities.
 - iii. Warehouse/distribution facilities.
 - iv. Other industrial uses deemed appropriate by the Planning Commission.
 - c. Multi-Family Residential uses.
 - i. Projects within R3, R4, and R5 zones.
 - 2. Design Standards. See Subsection 53.13, Design Standards for Off-Street Parking Facilities, of this Section.

-
- C. Disabled Accessible Parking Spaces. Parking spaces for the disabled shall comply in all respects with the requirements of the California Code of Regulations (State Building Code) or Federal law, where such prevails over State law.
 - D. Tandem Parking Spaces.
 - 1. Applicability. Tandem parking may be allowed with the approval of a Conditional Use Permit, in accordance with Section 57.04, Conditional Use Permits, of this Chapter.
 - 2. Standards.
 - a. Maximum allowed.
 - i. A maximum of seventy-five percent (75%) of parking required for residential uses may be tandem parking in projects with open structured parking facilities (e.g. single level or multi-level parking structures).
 - ii. A maximum of fifty percent (50%) of parking required for residential uses may be tandem parking in projects with private individual garages.
 - b. Tandem parking spaces shall be a maximum of two (2) parking spaces deep.
 - c. When tandem parking spaces are used in private garages or other parking facilities with more than two (2) parking spaces, they shall be assigned and marked for resident use.
 - E. Bicycle or Motorcycle Parking Spaces. The number of parking spaces required for various land uses shall be as required in Table 53.09-~~13~~, Number of Parking Spaces Required. Parking spaces shall be designed as required in Subsection 53.13, Design Standards for Off-Street Parking Facilities, of this Chapter.

(Ord. No. 38.785, § 7, 4-7-09)

XI-10-53.09 Off-Street Parking Required by Land Use

- A. Enforcement and Interpretation of Parking Requirements.
 - 1. Number of Off-Street Parking Spaces Required. The number of off-street parking spaces required for the land uses identified in the Permitted and Conditional Use Tables of this Chapter are listed in Table 53.09-~~13~~, Number of Parking Spaces Required, except where parking requirements are established in Section 13, Special Uses, of this Chapter, or exceptions to these requirements are granted in accordance with this Section.
 - 2. Uses not specified. In the case of a use not specifically mentioned in Table 53.09-~~13~~, Number of Parking Spaces Required, or elsewhere in this Chapter, the requirements for off-street parking facilities shall be determined by the Planning Commission through the Interpretation process, in accordance with Section 61, Interpretation, of this Chapter, based on uses which create similar demands for off-street parking spaces. The Planning Commission may draw upon the experience of other local cities to make their decision.
 - 3. New Buildings Without Tenants. If the type of tenants that will occupy a nonresidential building, or the nonresidential portion of a mixed-use building, is not known at the time the new building is being proposed, the number of parking spaces required for the nonresidential uses will be determined through the discretionary review process.
 - 4. Mixed occupancies and uses. When two or more uses are located in the same lot or parcel of land or within the same building, the number of off-street parking spaces required shall be the sum total of the requirements of the various individual uses computed separately in accordance with the provisions of this Section and Section 13, Special Uses, when applicable.

Exception: For alternative parking computation in accordance with Subsection 53.11, Shared Parking, of this Chapter.

5. Measurement Standards and Definitions. For the purpose of determining off-street parking requirements, the following definitions and standards shall apply:
 - a. Gross Floor Area: The total of all the floors measured from the interior faces of the building, and outdoor areas used for retail purposes.
 - b. Net Floor Area (NFA): Net Floor Area shall mean the Gross Floor Areas less twenty percent (20%).
 - c. Seat: The number of seating units installed or indicated, or each twenty-four (24) lineal inches of benches, pews, or space for loose chairs. For places of meeting or assembly that do not include fixed seating, seven (7) square feet shall equal one (1) seat.
 - d. Employees/students: The maximum number of employees/students on the principal shift or period.
 - e. Fractional Measurements: When units or measurements determining the number of required off-street parking spaces result in a requirement of fractional space, any fraction up to and including (.49) shall be rounded down to the nearest whole number and fractions including and over (.50) shall be rounded up to the nearest whole number. For example, 7.41 would be rounded to 7 and 7.61 would be rounded to 8.
6. More than One Parking Ratio. Where more than one (1) parking ratio is shown for a particular use, the required number of spaces shall be the total of all ratios shown. For example, the parking requirement for hotel is "1 per unit, 2 for the manager's unit." The total parking requirement for a hotel is the sum of the required parking for the units and two (2) spaces for the manager's unit.

B. Permissive Parking Facilities. Nothing in this Section shall prevent the voluntary establishment of off-street parking facilities in excess of the requirements of this Section to serve any existing use of land or buildings, provided that all regulations herein governing the location, size and access design, improvement and operation of such facilities are adhered to.

~~Exception: The Transit Area Specific Plan has a standard for the maximum number of parking allowed.~~

C. Number of Parking Spaces Required. The number of off-street parking spaces required for various land uses shall be as listed in Table 53.09-1~~3~~, Number of Parking Spaces Required, except for those listed specifically elsewhere in this Chapter. Unless otherwise indicated, the parking requirements are for square feet of gross floor area occupied by the use and, in the case of nonresidential uses, include the parking required for customers and employees.

~~Exception:~~ Exceptions:

1. Where a portion of a structure is used for automobile parking, that portion shall not be counted in calculating the required parking for the structure. If parking is eliminated and the space is occupied by another use, parking shall be required for the use as indicated for the use in this Chapter.
2. Metro Specific Plan Area. Off-street parking requirements and bicycle parking requirements for all uses in the Metro Specific Plan area are as follows:

Table 53.09-1
Vehicle Parking Requirements in the Metro Zones

<u>Use</u>	<u>Minimum</u>	<u>Maximum¹</u>
<u>Residential and lodging uses</u>	<u>None</u>	<u>1.5 spaces per unit</u>
<u>Industrial uses</u>	<u>None</u>	<u>2 spaces per 1,000 square feet</u>
<u>All other non-residential uses</u>	<u>None</u>	<u>1 space per 1,000 square feet</u>

¹ Valet, tandem spaces, and mechanical lift stalls are counted as individual spaces.

**Table 53.09-2
Bicycle Parking Requirements in the Metro Zones**

<u>Use</u>	<u>Minimum, Long-Term Spaces</u>	<u>Minimum, Short-Term Spaces</u>
<u>Multi-family residential uses</u>	<u>0.5 spaces per bedroom</u>	<u>0.1 spaces per bedroom</u>
<u>Retail uses</u>	<u>1 space per 10,000 square feet</u>	<u>1 space per 5,000 square feet</u>
<u>Offices, Business and Professional</u>	<u>1.5 spaces per 10,000 square feet</u>	<u>1 space per 20,000 square feet</u>
<u>All other uses</u>	<u>None</u>	<u>None</u>

**Table 53.09-3
Number of Parking Spaces Required**

Use	Minimum Parking Spaces Required
A. Commercial Uses	
Business Support Services	1 per 350 sq. ft.
Furniture and appliance stores and other bulky item retail; Furniture Repair and Reupholstery	1 per 350 sq. ft.
General Retail, <u>Grocery</u> and Convenience Stores <u>uses</u> ; Check Cashing	1 per 200 sq. ft.
Mortuary, funeral parlor	1 per 4 seats and 1 per employee
Personal Services	1 per 200 sq. ft.
Plant nursery	1 per 200 sq. ft.
Repair and Cleaning, Small Items	1 per 200 sq. ft.
B. Entertainment and Recreation	
Arcade and amusement	1 per 200 sq. ft.
Billiards	1 per 200 sq. ft.
Bowling Alleys including incidental accessory uses (eating and drinking, billiards, etc.)	6 per alley or lane
Clubs and Lodges	1 per 200 sq. ft.
Commercial Athletic Facility (indoor)	1 per 150 sq. ft.
With outdoor or indoor sports courts	
Small courts (tennis, badminton)	2 per court plus required parking for other uses on site.
Large courts (basketball, volleyball)	5 per court plus required parking for other uses on site.
Golf Course	6 per hole plus parking for ancillary uses
Miniature Golf	1.25 per tee, plus 1 per employee
Motion Picture Theater (indoor)	1 per 3.5 seats
Nightclub	1 per 30 sq. ft.
C. Health and Veterinarian Uses	
Convalescent Homes	1 per 2 beds or 1 per 1,000 sq. ft, whichever is greater
Hospital	1 per bed or 1 per 220 sq. ft., whichever is greater
Kennel, indoor	1 per 1,000
Massage Establishments	Two per treatment room or if no treatment room, one per 2 chairs or 2 tables
Medical and dental Clinic and Office	1 per 225 sq. ft.
Veterinary Clinic and Animal Grooming	1 per 250 sq. ft.

D. Industrial Uses	
<u>Custom and artisan manufacturing, Contractor's shop</u>	1 per 500 sq. ft.
Distribution <u>Data Centers</u> Manufacturing Processing/Plant (Dry-cleaning plant, photo finishing/printing, etc.) Warehousing <u>and Distribution</u>	1 per 1,500 sq. ft.
Mini Storage	1 per 5,000 sq. ft., plus 1 per resident manager
<u>Parcel hub</u>	<u>1 per 2,000 sq ft plus 1 truck parking space for each delivery vehicle on-site during the peak time. The requirement for delivery truck parking is not intended to accommodate semi trucks delivering products to the site.</u>
Wholesale <u>Sales</u>	1 per 500 sq. ft.
Research and Development Medical Laboratories Soils and Materials Testing Laboratories High employee demand uses	1 per 300 sq. ft.
Office space within an industrial building (to be combined with categories above)	1 per 350 sq. ft.
E. Lodging	
Extended Stay Hotels	0.7 per guest room or unit ⁵
Hotels	0.7 per guest room ⁵
Motels	0.7 per guest room ⁵
F. Professional Offices, Financial Institutions and Related Uses	
Automated Teller Machine (free standing)	2 per machine
Financial institutions (banks, savings and loans, etc.)	1 per 180 sq. ft.
Offices, business and professional	1 per 240 sq. ft.
G. Public, Quasi-Public and Assembly Uses	
Adult Day Care	1 per 500 sq. ft.
Auditoriums and theaters and places of meeting and assembly	1 per 4 seats
<i>Child Care Uses^{2, 3}:</i>	
Day Care School	1 per classroom or 1 per 500 sq. ft., whichever is greater.
Small family child care home	Same as required for underlying residential use
Large Family Child Care Home and Child Care Centers	1 per 1.5 employees
Community Center	1 per 4 fixed seats, or 1 per 6 linear feet of seating, plus 1 per 200 square feet of area without seating but designed for meeting or assembly by guests, plus 1 per 500 sq. ft. of outdoor area developed for recreational purposes
<u>Community Garden</u>	<u>Determined by Planning Director</u>
Museums	1 per 400 sq. ft.
Public Utilities	1 per 400 sq. ft.
Religious Institutions	1 per 5 seats in the main area of assembly plus parking for classrooms and offices in this table. Where there are no seats, then 1 seat equals 7 sq. ft.
<i>Educational Institutions:</i>	

	School-elementary (K-8 Private)	1 per classroom, plus 1 per 240 sq. ft. of office
	School-secondary (9-12 Private)	1 per classroom, plus 1 per 240 sq. ft. of office, plus 1 per 5 students
	Vocational School, including business, professional, technical and trade	1 per 200 sq. ft.
	Instructional Studios (Dance, Yoga)	1 per 150 sq. ft.
	Private instruction, personal enrichment (tutoring)	1 per instructional area or classroom, whichever is greater. No fewer than 3 spaces.
	Stadiums and arenas	1 per 4 seats
H. Restaurants or Food Service		
	Banquet facilities	See restaurants below
	Bars, Drinking Establishments	1 per 30 sq. ft.
	<u>Catering and Commissary</u>	<u>1 per 300 sq. ft. floor area</u>
	Drive thru	See "Vehicle Related Uses" section.
<i>Restaurants:</i>		
	Sit down:	
	Indoor and outdoor:	1 per 39 square feet of dining area.
	Take out:	1 per 2.5 seats (indoor/outdoor) plus 1 per 60 sq. ft. GFA for the ordering or take out area.
	Mobile food parks	1 per 2.5 seats provide for on-site dining, plus 1 per 60 sq. ft. of lot area dedicated to mobile food vending.
I. Residential Uses		
Single Family and Duplexes:		
	3 bedrooms or fewer	2 per unit ⁴
	4 or more bedrooms	3 per unit, plus 1 per each additional bedroom ⁴
Multi-Family (R3—R5 zones):		
	Studio	1 covered per unit
	1 bedroom	1.5 covered per unit
	2—3 bedrooms	2 covered per unit
	4 or more bedrooms	3 per unit, plus 1 additional space for each additional bedroom (at least two covered). ⁴
Guest parking		
	Projects with Parking structures	15% of the total required, may be uncovered
	Projects with Private garages	20% of the total required, may be uncovered
	Bicycle parking	5% of the total required
	Boarding houses, dormitories, sororities and fraternities, <u>group living accommodations</u>	1 per each room rented
	Live-Work Units	<i>Single family and duplexes</i> parking requirements shall apply, plus 1.5 for the commercial component
<i>Mixed Use buildings or sites</i>		
Residential use		
	Studio	1 covered per unit
	1 bedroom	1.5 covered per unit
	2—3 bedrooms	2 covered per unit
	4 or more bedrooms	3 per unit, plus 1 additional space for each additional bedroom (at least two covered). ⁴
	Guest parking	

Projects with Parking structures	15% of the total required, may be uncovered
Projects with Private garages	20% of the total required, may be uncovered
Bicycle parking	5% of total required
Commercial use	
Ground Floor Retail	1 per 250 sq. ft.
Office	If building is 1,000 sq. ft. or smaller: 1 per 250 sq. ft. If building is larger than 1,000 sq. ft.: 3.3 per 1,000 sq. ft.
Short-Term Rentals	1 per unit
Other uses	Refer to specific uses within this table
Bicycle parking	5% of total required
Mobile Homes	Refer to Section 13.07, Mobile Homes
<u>Residential Care Facility</u>	<u>1 for every three beds</u>
Senior Housing	1 per unit plus 2 per manager's unit
Single Room Occupancy (SRO)	1 per unit
J. Vehicle Related Uses	
Auto rental agency	1 per 400 sq. ft. plus 1 per rental vehicle
Auto repair (tire, oil change, smog check, etc.)	3 per service bay
Car Wash	1 per 200 sq. ft. of building area and reservoir space outside of building equal to two (2) times the maximum capacity of facility
<i>Gas & Service Stations:</i>	
With Retail	1 per 200 sq. ft.
With Auto Repair	3 per service bay
<i>Auto dealerships:</i>	
Sale or lease of vehicle	1 per 200 sq. ft. of showroom
Office	1 per 200 sq. ft.
With Service Bays	3 per service bay
Window service or drive-thru in conjunction with any other use	The required parking for primary use (restaurant, or other use providing window service) plus queuing of 5 vehicles which do not interfere with any on-site parking spaces

¹ Refer to Subsection 2.03, Definitions, of this Chapter for a full description of "Commercial Services."

² For loading and unloading: One (1) parking space per six (6) children up to five (5) spaces and thereafter one (1) space per ten (10) children. Driveways, garage aprons and street frontage may be counted if appropriate permits are first received when calculating spaces for child care homes. Tandem spaces are prohibited.

³ Exceptions for Child Care Requirements: The parking and loading/unloading requirements for child care facilities may in the Planning Commission's discretion be reduced, based on an empirical study (provided by the applicant) which establishes no adverse effects will occur as a result. The required number of loading/unloading spaces may be reduced without a study by one (1) space for each employee permanently assigned to load and unload children from vehicles.

⁴ Applicable to new and existing projects being remodeled resulting in additional bedrooms submitted for approval after April 7, 2009. Existing projects or projects either entitled or submitted active planning applications prior to April 7, 2009 shall use the parking regulations in effect at the time of entitlement or application submittal. For R4, R5, MXD/MXD2/MXD3 zones, 15% guest parking is legal and conforming for projects entitled or active planning applications submitted prior to April 7, 2009.

⁵ Refer to Subsection XI-10-53.15, Parking Standards for Hotels and Motels, of this Chapter for allowed reductions to minimum parking requirements.

(Ord. No. 38.848 , § 9, 11/15/22; Ord. No. 38.845 , § 13, 6/21/22; Ord. No. 38.841 , § 5, 5/4/21; Ord. No. 38.835 , § 8, 3/3/20; Ord. No. 38.839 , § 14, 12/3/19; Ord. No. 38.808, § 5, 5/21/13; Ord. No. 38.785, § 7, 4/7/09)

XI-10-53.11 Shared Parking

- A. Purpose and Intent. Dedicated parking areas for individual uses, especially when provided in new developments, can result in less efficient land usage, lower floor area ratios, and more environmental/water quality impacts.

Shared parking is typically applied when land uses have different parking demand patterns and are able to use the same parking spaces/areas throughout the day. Shared parking is most effective when these land uses have significantly different peak parking characteristics that vary by time of day, day of week, and/or season of the year. In these situations, shared parking strategies will result in fewer total parking spaces needed when compared to the total number of spaces needed for each land use or business separately.

- B. Applicability. Shared parking may be applied in the following situations:
1. In mixed-use developments, which include one or more businesses that are complementary, ancillary, or support other activities. A typical mix of uses includes, but is not limited to: residential, office, restaurants, retail, colleges, churches, cinemas, and special event situations if they can demonstrate that demand patterns vary among uses.
 2. In shopping centers, when more than twenty percent (20%) of gross leasable area is occupied by dining and entertainment uses, (not including pad restaurants, unless they are located within 300 feet of the main shopping center building) shared parking may be applied.
- C. Required Review. Shared parking proposals may be allowed with the approval of a Conditional Use Permit, in accordance with Subsection 57.04, Conditional Use Permits, of this Chapter.
- D. Calculation of Parking Spaces Required with Shared Parking. The minimum number of parking spaces for a mixed use development or where shared parking strategies are proposed shall be determined by a study prepared following the procedures of the Urban Land Institute Shared Parking Report, ITE Shared Parking Guidelines, or other approved procedures. A formal study may be waived for small developments where there is established experience with the land use mix and its impact is expected to be minimal. The actual number of parking spaces required shall be based on well-recognized sources of parking data such as the ULI or ITE reports. If standard rates are not available or limited, the applicant may collect data at similar sites to establish local parking demand rates. If the shared parking plan assumes use of an existing parking facility, then field surveys may be conducted to determine actual parking accumulation. If possible, these surveys should consider the seasonal peak period for the combination of land uses involved.
- E. Location of Shared Parking Spaces. Shared spaces shall be located within three hundred (300) feet of the use entrances they serve. Up to fifty percent (50%) of nonresidential spaces may be provided at greater distances if dedicated shuttle bus or van service is provided. Clear, safe pedestrian connections must be provided.
- F. Captive Market Parking Requirements. For uses that are considered ancillary to a larger business, no additional parking may be required. Examples of this case include a coffee or snack shop within an office or hotel development, a copy/package store within a business park or redevelopment of small retail uses in a large business district. Parking requirements for similar ancillary uses may be reduced to account for the likely cross patronage among the adjacent uses located within a maximum walking distance of three hundred (300) feet. Parking requirements may be reduced up to ninety percent (90%) as appropriate.
- G. Agreement Between Sharing Property Owners. If a parking facility is to serve two (2) or more separate properties, a legal agreement between property owners guaranteeing access to, use of, and management of designated spaces shall be executed to the satisfaction of the City.
- H. Shared Parking Plan. A shared parking plan shall be submitted to the Planning Division with the following information:
-

-
1. Site plan and required parking calculations of parking spaces intended for shared parking and their proximity to land uses that they will serve.
 2. A signage plan that directs drivers to the most convenient parking areas for each particular use or group of uses (if such distinctions can be made).
 3. A pedestrian circulation plan that shows connections and walkways between parking areas and land uses. These paths should be as direct and short as possible.

(Ord. No. 38.785, § 7, 4-7-09)

XI-10-53.13 Design Standards

A. Location of Parking.

1. Location of Parking in Relationship to a Use.
 - a. Residential Uses: Parking required for all residential uses shall conform with all of the following: (i) be located within the same project site as the use; (ii) be less than 300 feet away from the residential unit it serves; and (iii) shall not be located on any public street, public right-of-way or in any other public area.
 - b. Commercial Services and Retail Stores in the **TransitMetro** or Midtown Specific Plan Areas: Commercial service and retail uses may meet its parking requirements with on-street parking if the project satisfies all of the following conditions: (i) the project site is located within the **TransitMetro** or Midtown Specific Plan Areas; (ii) the on-street parking space is located along the project site frontage directly serving and adjacent to the use; (iii) no more than 50 percent of the required parking spaces shall be allocated on-street unless the commercial or retail use requires ten or less parking spaces; (iv) the on-street parking space is located less than 300 feet away from the use it serves; and (v) the on-street parking space shall be designated as limited time parking in accordance with the California Vehicle Code.
 - c. Other Uses: Required parking for all other uses shall conform with all of the following: (i) be located within the same project site as the use; (ii) be less than 300 feet away from the use for which the parking is required, as provided for in Table 53.09-13 Number of Parking Spaces Required or Section 13, Special Uses, of this Chapter; and, (iii) shall not be located on any public street, public right-of-way or in any other public area.
 2. Location of Residential Parking, Permitted. Vehicles on private property used for residential purposes shall be parked only in paved parking spaces or in driveways which comply with the following standards:
 - a. The driveway provides access to required parking spaces; and
 - b. The vehicle is not blocking access to parking for other residential units.
 3. Each automobile parking stall shall be so located that no automobile is required to back onto any public street or sidewalk to leave the parking stall, parking bay or driveway except from a lot in an "R2" or more restrictive zone containing not more than two (2) dwelling units.
 4. Parking Location for R5, MXD2 and MXD3 projects.
 - a. No parking spaces area allowed within the front or street side setback areas.
 - b. Parking must be located behind buildings to minimize visibility from public streets.
 - c. At least seventy percent (70%) of the street facing perimeter of above-ground parking shall be wrapped with habitable space.
-

Exception: Exceptions may be allowed through the approval of a Conditional Use Permit, if the design quality of the structure is equivalent to habitable space.

- d. Parking may be partially above grade along the street, provided that no more than four (4) feet of the structure is above grade. The above-grade area must be wrapped with continuous landscaping that screens parking garage openings.
5. Parking Structure access for R5, MXD2 and MXD3 projects.
 - a. No more than one curb cut per street frontage is allowed.
 - b. Parking structure entrances shall be no greater than twenty-two (22) feet wide.
 - c. Parking structure access points shall be set back from the curb so that a car can pull up to the entry gate or ticket machine without blocking the sidewalk.
- B. Parking Space Size.
 1. Individual garage.
 - a. Each parking space with a minimum width of ten (10) feet and a minimum length of twenty (20) feet shall be required in residential garages meeting both of the following criteria:
 - i. The individual garage contains four (4) or fewer parking spaces;
 - ii. The individual garage does not include circulation elements such as driveway aisles, but consists primarily of parking spaces.
 2. Compact Spaces
 - a. Each stall shall be legibly marked "compact stall" or "small car" on the stall surface. Compact stalls may be used only for the above-listed buildings and uses and only within the Industrial zoning district.
 - b. Parking stalls shall be dispersed throughout the parking lot and not concentrated to discourage oversized vehicles from using the stalls.
 3. Tandem Spaces
 - a. Each residential garage tandem (two parking spaces) shall have a minimum width of ten (10) feet and a minimum length of thirty-eight (38) feet.
 4. Bicycle or Motorcycle Spaces. Any existing or proposed parking facility may utilize, on a substitution basis, on-site parking spaces for bicycle or motorcycle spaces.
 - a. Said bicycle spaces shall be raised a minimum of six (6) inches from grade of the adjacent parking facility.
 - b. One parking space may be omitted for each eight (8) bicycle spaces provided.
 - c. One parking space may be omitted for each two (2) motorcycle spaces provided.
 - d. Bicycle spaces shall measure at least two (2) feet by seven (7) feet and shall be located in groups of four (4) and shall be of the following three types:
 - i. A rack which secures the frame, or
 - ii. An enclosed bike locker, or
 - iii. A fenced, covered, locked or guarded bike storage area.
 - e. Motorcycle spaces shall measure four (4) feet by eight (8) feet and shall be provided with adequate unobstructed maneuvering areas to permit easy access to the space.

- f. In no instance shall credit for motorcycle or bicycle parking or combination thereof exceed five percent (5%) of the total required parking spaces.
- C. Required Improvements. All parking areas and access driveways shall have a smoothly graded, stabilized and dustless surface with adequate drainage so that injury will not be caused to adjacent properties. Bumper guards or curbs shall be provided in order to define parking spaces or limits of paved areas.
- Also refer to Section 54.03 of this Chapter for Improvement of Parking Areas.
- D. Screening and Landscaping. All open automobile parking areas which abut upon a public street right-of-way shall provide landscaping to a depth of at least ten (10) feet of said street right-of-way and of any adopted plan line, with openings for walkway or drive purposes. Each landscaped planter in said parking facility shall be contained with a six (6) inch raised concrete curb (extruded curbing not permitted). Installation of an irrigation system shall be provided for in each planter area.
- E. Lighting. All lights used to illuminate a parking area shall be designed, located and arranged so as to reflect the light away from any street and any adjacent premises.
- F. Signs. Directional signs are permitted in parking areas in accordance with the adopted Sign Ordinance.
- G. Fencing. A solid masonry wall a minimum height of six (6) feet shall be required on all common property lines when any parking area is established abutting residentially zoned property or property shown on the adopted General Plan as being Residential. The architectural design of said wall shall be to the approval of the Planning Commission through the Site Development Permit process in accordance with Subsection 57.03, Site Development Permits and Minor Site Development Permits, of this Chapter.
- H. Angles and Dimensions
1. Vehicle Overhang. Vehicles may overhang two (2) feet into any landscape area or private walkway if the walkway is a minimum six (6) feet in width, but in no event shall the overhang be permitted within any public right-of-way.
 2. Stall and drive aisle dimensions. The stall and drive aisle dimensions shall be as follows:

**Table 53.13-1
Parking Stall and Drive Aisle Dimensions**

Angle	A ¹ Stall Width	B ¹ Stall Depth	C ¹ Aisle Width 1 Way	D ¹ Aisle Width 2 Way	E ¹ Curb Length per Car
Standard size:					
0°	9'	9'	12'	16'	22'
45°	9'	19.5'	12'	22'	12'
60°	9'	21'	18'	22'	10.5'
90°	9'	18'	24'	24'	9'
Compact size: [See Subsection 53.07(B)]					
0°	7.5'	7.5'	12'	15'	17'
45°	7.5'	16'	13'	20'	8.5'
60°	7.5'	17'	15'	20'	8.5'
90°	7.5'	15'	20'	20'	7.5'

¹ Reference to Figure 53.13-1, Parking Stall and Drive Aisle Dimensions

**Figure 53.13-1
Parking Stall and Drive Aisle Dimensions**

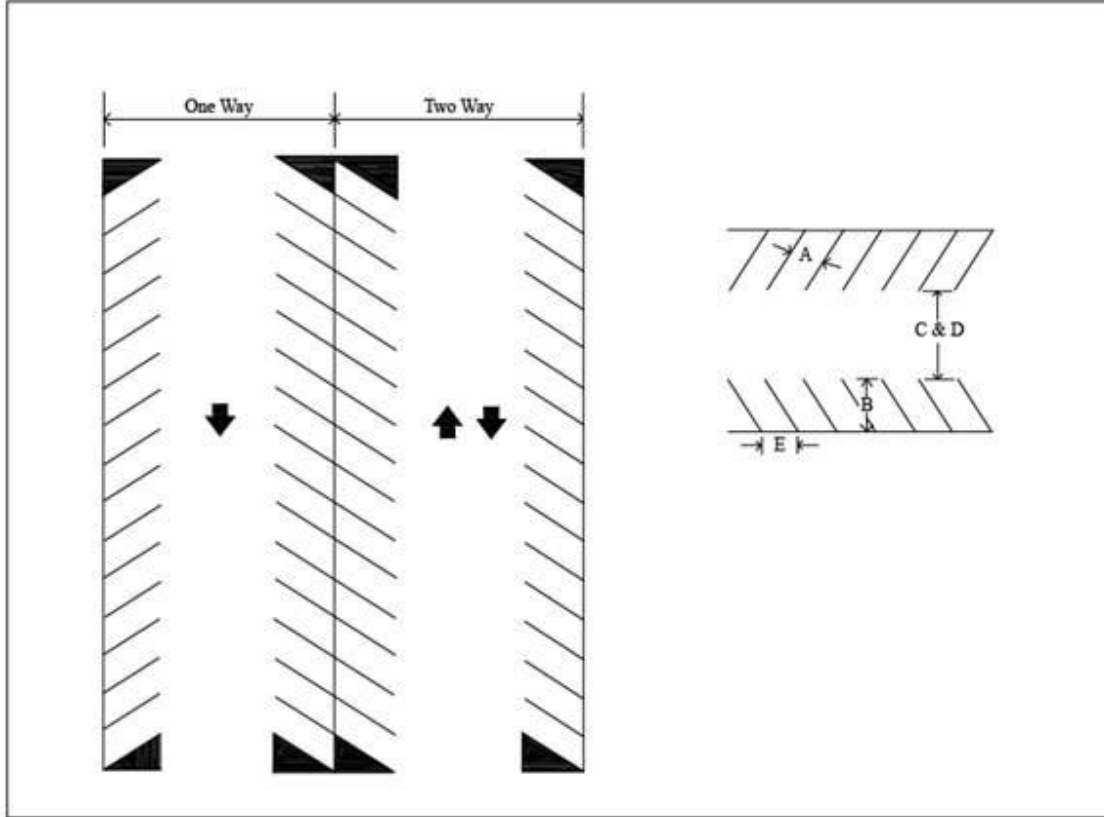

3. Backing Space in Residential Projects. A minimum unobstructed vehicular maneuvering distance of 25 feet measured from the opening of the garage or carport shall be provided, except as otherwise permitted in this section.
4. Parking Structures. The parking stall and drive aisle dimensions for Parking Structures, as defined in this Chapter, may be modified with the approval of a Conditional Use Permit in accordance with Section 57 of this Chapter.

(Ord. No. 38.815, § 2, 9-2-14; Ord. No. 38.785, § 7, 4-7-09)

XI-10-53.15 Allowed Reductions to Required Parking for Lodging Uses

- A. Allowed Reductions to Minimum Required Parking. The required parking for lodging uses, including hotels, motels, and extended stay hotels, may be reduced by up to 30 percent at the discretion of the decision-making authority based on a demonstrated program to reduce demand for on-site parking and maximize the efficient use of parking areas. A reduction in required parking shall be granted based on a point system as described in Subsection XI-10-53.15.C.
- B. An applicant requesting a reduction to the minimum required parking for a lodging use shall submit a written description of all proposed parking demand reduction and site design measures and a written justification of the anticipated reduction in parking demand that would result from implementation of such measures.
- C. Point System for Calculation of Parking Reduction. The decision-making authority may grant a reduction in the required number of parking spaces for lodging uses, as outlined in Table 53.15-1, according to the total number of points scored for implementation of parking demand reduction and site design measures.

**Table 53.15-1
Point System for Parking Reduction for Lodging Uses**

Total Points	Allowed Parking Reduction
60 points or more	30 percent
40 points or more	20 percent
20 points or more	10 percent

1. Parking Reduction for Lodging Near Fixed Guideway Transit. A parking reduction may be granted for a lodging establishment within one-half (0.5) mile of a fixed guideway transit station. Fixed guideway transit means a public transit facility that uses and occupies a separate right-of-way or rail line for the exclusive use of public transit vehicles (15 points).
2. On-Site Parking Demand Reduction and Site Design Measures for Lodging Uses. Any combination of the following measures may be incorporated into the site plan and operational plan for a hotel, motel, or extended stay hotel to support a reduction in the minimum required on-site parking:
 - a. Shared parking agreement with owners of other property or properties in the vicinity of the lodging establishment pursuant to Subsection XI-10-53.11, Shared Parking, of this Chapter. The shared parking spaces must be located within 0.25 mile of the lodging use (10 points for a number of shared parking spaces totaling between 10 and 20 percent of the base parking space requirement for the lodging use; 15 points for a number of shared parking spaces totaling more than 20 percent of the base parking space requirement for the lodging use).
 - b. Providing free monthly transit passes for employees. To qualify for this measure a lodging use must be located within 0.5 mile of a transit route (bus or rail) with service frequency of every 15 minutes or less between the hours of 7:00 a.m. and 7:00 p.m. (10 points).
 - c. Providing free 24-hour airport guest shuttle service (10 points).
 - d. Providing free guest shuttle service to other key destinations (including but not limited to BART and VTA light rail stations, San Jose Diridon Caltrain Station, Levi's Stadium, and major commercial centers) (5 points for shuttle service serving one or two destinations, 10 points for shuttle service serving three or more destinations).
 - e. Providing free shared cars for guest use with dedicated, permanent on-site parking spaces for the shared cars . To qualify for this measure the lodging use must provide at least one shared car for every 50 guest rooms (when applying this calculation, any fractional number of required shared cars shall be rounded up to the nearest whole number) (10 points).
 - f. Providing on-site, free micromobility devices for guest use. To qualify for this measure the lodging use must provide at least one shared micromobility device for every 50 guest rooms (when applying this calculation, any fractional number of required shared micromobility devices shall be rounded up to the nearest whole number). The operator of the lodging establishment shall obtain approval from the Planning Director or designee for the proposed placement and use of micromobility devices prior to commencing operations. The operator of the lodging establishment shall maintain micromobility devices in good working order at all times (5 points).
 - g. Providing valet parking (on-site or at an off-site shared parking location) (5 points for a number of valet parking spaces totaling between 10 and 20 percent of the base parking space requirement for the lodging use; 10 points for a number of valet parking spaces totaling more than 20 percent of the base parking space requirement for the lodging use).
 - h. Mechanical lifts for vehicles (if provided, lifts must be operated by staff of the lodging establishment) (5 points for a number of mechanical lift spaces totaling between 10 and 20 percent of the base parking space requirement for the lodging use; 10 points for a number of

mechanical lift spaces totaling more than 20 percent of the base parking space requirement for the lodging use).

- i. Charging a daily fee of \$25 or more for on-site parking of guest vehicles (10 points).
- j. Offering prepaid transit cards (Clipper) to guests (5 points).
- k. Featuring public transportation information and links on lodging establishment's website (schedules and route maps for Valley Transportation Authority [VTA] bus and light rail and/or Bay Area Rapid Transit [BART] regional rail) (3 points).
- l. Providing dedicated on-site passenger pickup/dropoff zones (3 points).
- m. Active marketing of guest shuttle services, on-site shared cars, and/or on-site shared micromobility devices, via the lodging establishment's website and other electronic and/or print advertising materials (3 points).
- n. Other measures as preproposed by lodging establishment operator (points to be determined by the decision-making authority based on the potential for parking demand reduction of the proposed measure).

(Ord. No. 38.841 , § 6, 5/4/21)

Section 54 General Provisions

XI-10-54.18 ~~Reserved.~~ 2023-2031 Housing Element Sites

- A. Reused Sites. Reused sites are opportunity and rezone sites listed in the City of Milpitas 2023-2031 Housing Element, Appendix E, Tables E-13 and E-14 that are identified for lower-income housing capacity and as a 5th Cycle Housing Element site. On these reused sites, owner-occupied and rental multi-family housing uses shall be allowed by right (i.e., without any discretionary review) when at least 20 percent of the units will be affordable to lower income households.
- B. Rezone Sites. Rezone sites are listed in the City of Milpitas 2023-2031 Housing Element, Appendix E, Table E-14 that are identified for lower-income housing capacity. On these rezone sites, the following shall apply:
1. Owner-occupied and rental multi-family housing uses shall be allowed by right (i.e., without any discretionary review) when at least 20 percent of the units will be affordable to lower income households.
 2. 100 percent residential use is allowed.
 3. A minimum of 50 percent of the floor area in mixed-use projects must be occupied by residential use.

Editor's note(s)—Ord. No. 38.795, § 35, adopted April 6, 2010, amended the Code by repealing former § XI-10-54.18 in its entirety. Former § XI-10-54.18 pertained to temporary contractor's offices, and derived from Ord. 38.780 (25) (part), adopted August 19, 2008.

Section 56 Nonconforming Buildings, Uses, and Uses Parcels*

* Prior ordinance history: Ords. 38, 38.681 and 38.760.

XI-10-56.01 Purpose and Intent

The purpose of this chapter is to establish regulations for nonconforming buildings, structures and uses. It is the intent of these regulations to result in the conversion of nonconforming buildings, structures, and uses to conforming buildings, structures and uses. However, the City recognizes that until nonconforming buildings, structures, and uses are converted, improvements to them which promote their compatibility with their neighborhoods, enhance the quality of development, and do not increase nonconformity should be encouraged and allowed.

(Ord. 38.777 (14) (part), 6/17/08)

XI-10-56.02 Repair, Maintenance and Improvements to Nonconforming Buildings and Structures

A nonconforming building or structure may be maintained, except as otherwise provided in this section.

- A. Repair, Maintenance, Aesthetic Improvements. Repairs and alterations may be made to a nonconforming building or structure, provided that no structural alterations shall be made except those required by law or ordinance.
- B. Energy Efficiency and Sustainability Upgrades. Improvements may be made to a nonconforming building or structure related to improving the energy efficiency, reducing the energy usage, and reducing the greenhouse gas emissions impact of the building or structure.
- C. Restoration of Damaged Buildings. A nonconforming building or structure which is damaged or partially destroyed by fire, flood, wind, earthquake, or other calamity or act of God or the public enemy, to the extent of not more than seventy-five (75%) percent of its true value at that time, may be restored and the occupancy or use of such building, structure or part thereof, which existed at the time of such partial destruction, may be continued or resumed, provided the total cost of such restoration does not exceed seventy-five (75%) percent of the true value of the building or structure at the time of such damage and that such restoration is started within a period of one (1) year and is diligently prosecuted to completion.

In the event such damage or destruction exceeds seventy-five (75%) percent of the true value of such nonconforming building or structure, no repairs or reconstruction shall be made unless every portion of such building or structure is made to conform to all regulations for new buildings in the district in which it is located.

Provided, however, that any multistory single-family residence, which is subject to the provisions of the hillside section of this Title (Section XI-10-45), may be rebuilt to its approved height and setbacks and is not subject to the single-story height restrictions or other restrictions in the Zoning Title currently in effect, but shall conform to those regulations in effect at the time the structure was built.
- ~~D.~~ Additions to, Enlargements and Moving of Nonconforming Buildings and Structures.
 1. In the R1, R2 and R1-H Districts, a legal nonconforming building or structure shall not be added to or enlarged in any manner unless the addition or enlargement conforms to all development standards and regulations of the district in which it resides, including, but not limited to height, yard setbacks,

maximum lot coverage, impervious surface coverage, and maximum size of residence regulations of said district. In addition, a legal nonconforming building or structure shall not be added to or enlarged unless existing front yard paving is brought into conformance.

2. In all districts other than the R1, R2, and R1-H, a legal nonconforming building or structure may be added to or enlarged in a manner consistent with the criteria established in Table XI-10-57.04-1 and if a Conditional Use Permit is obtained.
3. A building or structure lacking adequate automobile parking space in connection therewith may be altered or enlarged provided the required additional automobile parking space is supplied as per Section XI-10-53 for the entire building or use, including the addition or enlargement.
4. A nonconforming building or structure shall not be moved in whole or in part to any other location on the lot unless every portion of such building or structure is made to conform to all regulations of the district in which it is located.

(Ord. No. 38.793, § 3, 5/17/11; Ord. 38.777 (14) (part), 6/17/08)

XI-10-56.03 Nonconforming Use of Buildings and Structures

- A. The continuation or change of a nonconforming use of a building or structure shall meet the requirements provided below.
 1. Continuation of Existing Nonconforming Use. A legally established use that is no longer permitted in a particular zoning district because of a modification of this Chapter shall be allowed to continue indefinitely, absent discontinuation of the use for a year or more and failure to comply with the re-establishment provisions of Section XI-10-56.03(B) below.
 2. Discontinuation of Nonconforming Use. The nonconforming use of a building, structure or portion thereof, which is discontinued for a continuous period of one (1) year or more, may be replaced only with a conforming use, absent an approved nonconforming use reestablishment set forth in Section XI-10-56.03(B) below. Nonconforming uses which have been discontinued for a period of less than one (1) year may be replaced, if (1) with a nonconforming use of the same use classification as a matter of right or (2) a nonconforming use of a different use classification, subject to compliance with the findings and procedures set forth Section XI-10-56.03(B).
 3. Changes of Use Within the Same Use Classification. An existing, ongoing nonconforming use may be changed to a different use within the same use classification. For example, a nonconforming auto repair shop use may be changed to a tire shop use, since both uses fall within the same use classification (auto service uses).
 4. Change of Use to a Different Nonconforming Use Classification. An existing, ongoing nonconforming use may be changed to a nonconforming use of a different use classification only if it can be found that the proposed use is equivalent to or more appropriate than the existing nonconforming use at the project location. The proposed use may be allowed only by way of a conditional use permit and only if, in addition, all of the following findings can be made:
 - a. The proposed nonconforming use would not cause a nuisance to the surrounding properties and district (e.g., excessive parking demand, traffic, noise, etc.).
 - b. The proposed nonconforming use would be compatible with the general character of the surrounding neighborhood or district.
 - c. The proposed nonconforming use is necessary to allow gainful economic use of structures or improvements until such structures or improvements can be permanently converted to conforming uses.

B. Re-establishment of Discontinued Nonconforming Uses Within the ~~Midtown and Transit Area~~ Milpitas Metro Specific Plan ~~Areas~~ Area (Sunsetting Provision).

1. Once discontinued for a year or more, nonconforming uses only within the ~~Midtown Specific Plan Area~~ and the Transit Area Milpitas Metro Specific Plan Area may be re-established if all of the following findings can be made:
 - a. The proposed re-establishment of a nonconforming use would not cause a nuisance to the surrounding properties and district (e.g., excessive parking demand, traffic, noise, etc.).
 - b. The proposed re-establishment of a nonconforming use would be compatible with the existing general character of the surrounding neighborhood or district.
 - c. The proposed re-establishment of a nonconforming use is necessary to allow gainful economic use of structures or improvements until such structures or improvements can be permanently converted to conforming uses.

In addition to the above findings, the re-establishment of a discontinued nonconforming use may only be approved by the Planning Commission by way of a conditional use permit, with the above additional findings, if (1) the proposed use lies within 1,000 feet of any residential use or (2) the proposed use would require conditional use permit review under current zoning requirements for the zoning district listed in the zoning map in existence at the time the use became nonconforming. The re-establishment of a discontinued nonconforming use may be approved administratively by Planning Division staff in all other circumstances, contingent on the existence of findings by Planning Division staff that the above listed grounds for re-establishment exist.

2. This Section XI-10-56.03(B) shall become inoperative ~~June 16, 2016~~ July 1, 2026, and shall be considered repealed on that date, unless a later enacted ordinance that becomes effective on or before ~~June 16, 2016~~ July 1, 2026, deletes or extends that date. All other provisions of Section XI-10-56.03 shall be unaffected by this sunset clause.

C. Expansion of Assembly Uses in the Heavy Industrial (M2) Zoning District.

1. Assembly uses approved after February 7, 2017, that are rendered legally non-conforming may expand in floor area up to 25 percent of existing floor area until December 31, 2020. Such expansions shall require approval of a Site Development Permit and Conditional Use Permit by the Planning Commission in accordance with the provisions of Section 57 "Applications."

(Ord. No. 38.837 , § 10, 11/5/19; Ord. No. 38.817, § 2, 9/16/14; Ord. No. 38.793, § 3, 5/17/11; Ord. 38.777 (14) (part), 6/17/08)

XI-10-56.04 Nonconforming Use of Land

1. Continuation of Use. The nonconforming use of land (where no main building is involved), existing at the time the Ordinance codified in this section became effective, may be continued for a period of not more than five (5) years therefrom, provided:
 - a. That no such nonconforming use of land shall, in any way, be expanded or extended either on the same or adjoining property.
 - b. That, if such nonconforming use of land, or any portion thereof, is discontinued or changed, any future use of land shall be in conformity with the provisions of this Chapter.
 - c. That any sign, billboard, commercial advertising structure or statuary, which is lawfully existing and maintained prior to January 26, 1954, may be continued, although such use does not conform with the provisions hereof; provided, however, that no structural alterations are made thereto and provided, further, that all such nonconforming signs, billboards, commercial advertising structures and statuary,

and their supporting members, shall be completely removed from the premises not later than five (5) years from the effective date of the Ordinance codified in this section.

2. Nonconforming Due to Reclassification. The foregoing provisions of this section shall also apply to buildings, structures, land, or uses which hereafter become nonconforming due to any reclassification of districts under this Chapter or any subsequent change in the regulations of this Chapter; provided, however, that where a period of years is specified in this section for the removal of nonconforming buildings, structures, or uses, said period shall be computed from the date of such reclassification or change.

(Ord. 38.777 (14) (part), 6/17/08)

XI-10-56.05 Nonconforming Parcels

- A. Legal Building Site. A nonconforming parcel that does not comply with the applicable lot requirements for the zone (e.g., lot area, lot width, etc.) in which it is located shall be considered a legal building site if it meets at least one of the following:
 1. The parcel was created by a recorded subdivision;
 2. The parcel is under one ownership and of record, and was legally created by a recorded deed prior to the effective date of the zoning amendment that made the parcel nonconforming; or
 3. The parcel was approved through a variance procedure or resulted from a lot line adjustment.
- B. Development of Legal Building Sites. A legal building site may be developed provided that any structure or development complies with the standards for the zone unless standards are specifically waived or altered through a variance or as otherwise allowed by the zoning ordinance.
- C. Subdivision or Adjustment of a Nonconforming Parcel. No subdivision or lot line adjustment shall be approved that would increase the nonconformity of an existing parcel.

